

OPERATING AND MAINTENANCE MANUAL

# **ICE MODEL 416L**

VIBRATORY PILE DRIVER/EXTRACTOR

WITH MODEL 325 POWER PACK

SERIAL NUMBERS: 182940 AND ABOVE

OM-416/325-0195



**INTERNATIONAL  
CONSTRUCTION  
EQUIPMENT, INC**

SPECIALIZING IN PILE DRIVING EQUIPMENT

CORPORATE OFFICES: 301 WAREHOUSE DR., MATHEWS, NC 28105  
PHONES: 800 438-9281 & 704 821-7681      TELEX 572385 ICE INTL



## PREFACE

This manual was prepared to acquaint the owner, operator and serviceman with the operation and maintenance of the vibratory driver/extractor. We suggest that this manual be carefully studied before operating or undertaking any maintenance work on the unit.

This manual is organized into two major categories.

The first category is for routine OPERATING INSTRUCTIONS of the unit and includes a GENERAL DESCRIPTION section, which presents a basic explanation of the driver/extractor and some of its specifications. The MAINTENANCE AND ADJUSTMENT section should be referred to periodically for normal servicing of equipment. All machines and equipment require systematic, periodic inspection and maintenance, if they are to perform satisfactorily, over a long period of time. The driver/extractor is primarily a vibrating machine and if not given the best of care, or if improperly used and maintained, it is self-destructive. Therefore, the unit should receive at least the same care and maintenance as other high quality construction equipment.

The second category is for parts reordering and it includes both a PARTS LIST and a pictorial drawing of the assembly, for easier determination of the required part. Refer to the ORDERING PARTS section of the PARTS LIST for more specific procedures regarding parts ordering. Adherence of the listed procedures will insure receipt of the required part(s) with the minimal amount of delay or error.



## **WARRANTY**

### **INTERNATIONAL CONSTRUCTION EQUIPMENT STANDARD WARRANTY**

International Construction Equipment (ICE) warrants new products sold by it to be free from defects in material or workmanship for a period of 90 days after date of delivery to the first user and subject to the following conditions:

ICE's obligation and liability under this WARRANTY is expressly limited to repairing or replacing, at ICE's option, any parts which appear to ICE, upon inspection, to have been defective in material or workmanship. Such parts shall be provided at no cost to the user, at the business establishment of ICE or the authorized ICE distributor of the product, during regular working hours. This WARRANTY shall not apply to component parts or accessories of products not manufactured by ICE and which may carry the warranty of the manufacturer thereof, or to normal maintenance (such as engine tune-up) or to normal maintenance parts (such as oil filters). Replacement or repair parts installed in the product covered by this WARRANTY are warranted only for the remainder of the warranty, as if such parts were original components of said product. ICE COMPANY MAKES NO OTHER WARRANTY, EXPRESS OR IMPLIED, AND MAKES NO WARRANTY OF MERCHANTABILITY OR FITNESS, FOR ANY PARTICULAR PURPOSE.

ICE's obligation under this WARRANTY shall not include any transportation charges, cost of installation, duty, taxes or any other charges whatsoever, or any liability for direct, indirect, incidental, or consequential damage of delay. If requested by ICE, products or parts for which a warranty claim is made are to be returned, transportation prepaid to ICE. Any improper use, including operation after discovery of defective or worn parts, operation beyond rated capacity, substitution of parts not approved by ICE or any alteration or repair by others in such manner as in ICE's judgement affects the product materially and adversely, shall void this WARRANTY.

**NO EMPLOYEE OR REPRESENTATIVE IS AUTHORIZED TO CHANGE THIS WARRANTY IN ANY WAY OR GRANT ANY OTHER WARRANTY UNLESS SUCH CHANGE IS MADE IN WRITING AND SIGNED BY AN OFFICER OF ICE.**

## TABLE OF CONTENTS

### OPERATING INSTRUCTIONS

	<u>PAGE</u>
I. <u>GENERAL DESCRIPTION</u>	
A. General	I- 1
B. Vibrator	I- 2
C. Hydraulic Clamp	I- 2
D. Power Unit	I- 2
E. Remote-Control Pendant	I- 3
F. Specifications	I- 3
II. <u>PREPARATION FOR OPERATING</u>	
A. General	II- 1
B. Safety Precautions	II- 1
C. Rigging of Vibrator	II- 2
D. Connection of Hydraulic Clamp	II- 2
E. Connection of Hydraulic Hoses	II- 3
F. Bleeding Hydraulic Clamp Hoses	II- 5
G. Filling Vibrator Pressure Hose	II- 5
III. <u>OPERATING INSTRUCTIONS</u>	
A. Completion of Set-Up and Maintenance	III- 2
B. Control Panel	III- 2
C. Starting and Warming Up Engine	III- 3
D. Warming Hydraulic Fluid	III- 3
E. Operation of Remote-Control Pendant	III- 4
F. Changing Frequency	III- 5
G. Shutdown	III- 6
IV. <u>MAINTENANCE AND ADJUSTMENTS</u>	
A. General	IV- 1
B. Daily	IV- 1
C. 100 Hours, 500 Hours and Other	IV- 2
D. Annually	IV- 2
E. Severe Conditions	IV- 3
F. Lubrication	IV- 3
G. Capacities	IV- 7
H. Draining and Filling Hydraulic Fluid Reservoir	IV- 8
I. Changing Hydraulic Return Filter Element	IV- 8
J. Bolt Torque Information	IV- 9

**TABLE OF CONTENTS**

OPERATING INSTRUCTIONS (CONTINUED)

<u>V.</u>	<u>HYDRAULIC CIRCUITRY</u>	<u>PAGE</u>
	A. Hydraulic Clamp	V- 1
	B. Vibrator Drive	V- 1
	C. Auger Drive	V- 3
	D. Hydraulic Impact Hammer	V- 3
	E. Other	V- 3
	Hydraulic Schematic	V- 4
	F. Hydraulic Components List	V- 5
<u>VI.</u>	<u>ELECTRICAL CIRCUITY</u>	
	A. Diesel Engine	VI- 1
	B. Hydraulic Clamp	VI- 2
	C. Vibrator	VI- 2
	D. Other	VI- 2
	Electrical Schematic	VI- 3
	E. Electrical Components List	VI- 4
	Electrical Diagram	VI- 5

PARTS LIST

<u>VII.</u>	<u>GENERAL DATA</u>	
	A. Abbreviations	VII- 1
	B. Screws and Bolts	VII- 1
	C. Serial Number Locations	VII- 2
<u>VIII.</u>	<u>ORDERING PARTS</u>	
	A. Procedure	VIII- 1
	B. Fitting Description Key	VIII- 2
	Fitting Style Selector Chart - SC1	VIII- 3
	C. Hose Description Code	VIII- 4
	D. Parts Identification	VIII- 5
	Parts Lists and Drawings	VIII-6 thur
	E. Miscellaneous Accessories	VIII-40
	F. Recommended Spare Parts	VIII-44





I. GENERAL DESCRIPTION

A. GENERAL

The ICE Model 416L is a low-frequency vibratory pile driver/extractor designed to drive and extract sheet, pipe, timber and concrete piles, caisson pipe and H, I and wide-flange beams.

The Model 416L operates in a frequency range of 700 to 1540 vibrations per minute to provide maximum pile penetration rates in a wide variety of soils. The unit has an eccentric moment of 2200 inch-pounds and operates with an amplitude of 1/4 to 3/4 inch.

The vibratory driver unit consists of two major components. (1) The vibrator with attached clamp and (2) the power unit with remote control pendant.

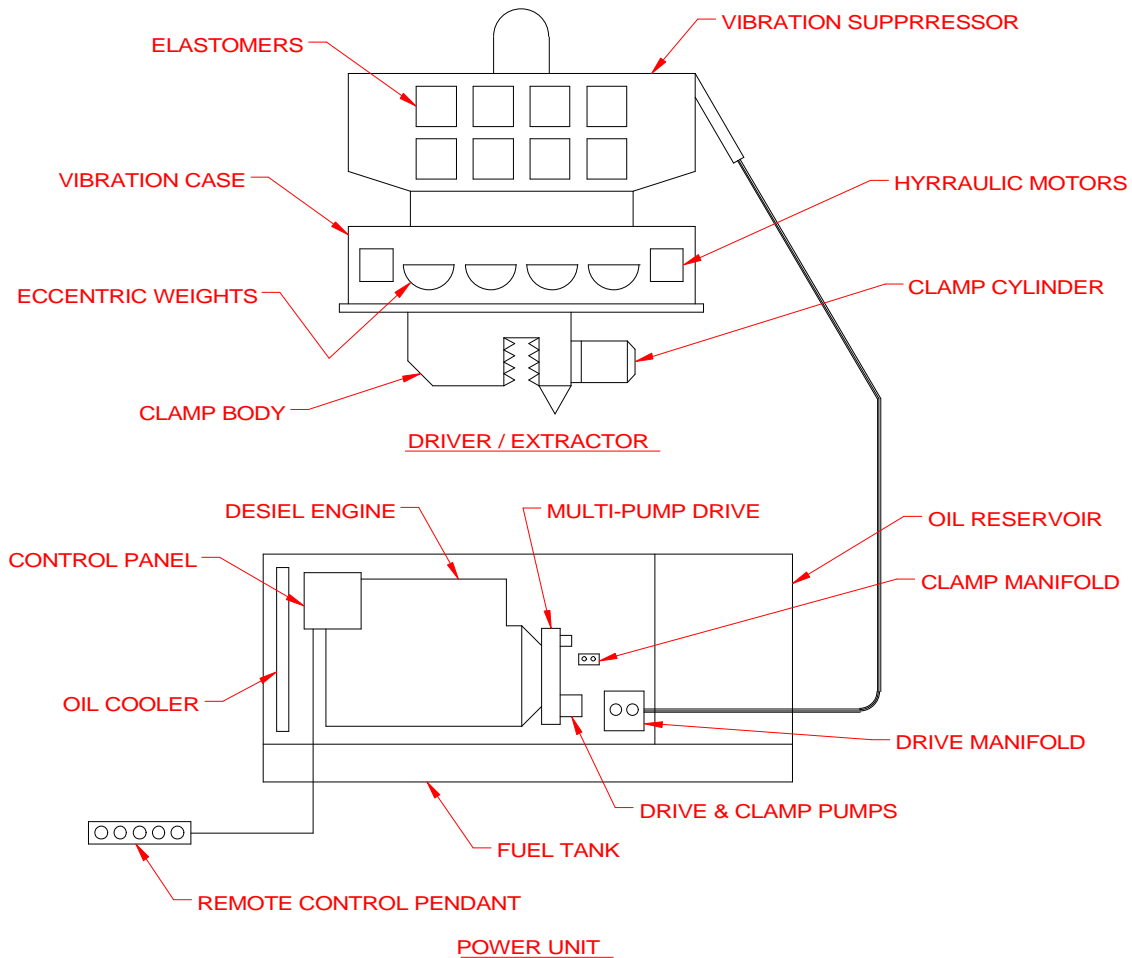

## I. GENERAL DESCRIPTION

### B. VIBRATOR

The vibrator consists of two major components. (1) The vibration case and (2) the vibration suppressor.

The vibration case contains four eccentric weights which rotate in a vertical plane to create vibration. The eccentric weights are driven by two hydraulic motors mounted on the vibration case. The two motors and four eccentrics are all gear connected to maintain proper synchronization. The eccentric and motor shafts are mounted in heavy-duty cylindrical roller bearings. Lubrication is provided by a splash system activated by the rotating eccentrics and gears.

A suppressor assembly is mounted to the top of the vibration case, to isolate vibration from the crane and permit pile extraction. A, heavy, outer suppressor housing is connected to the vibration case by sixteen (16) rubber elastomers. Up to forty (40) tons of crane line pull may be applied to this suppressor during extraction.

### C. HYDRAULIC CLAMP

A hydraulic clamp, bolted to the bottom of the vibration case, transmits vibration to the piling. The hydraulic clamp contains two gripping jaws; one fixed and one moveable. A large hydraulic cylinder operates the moveable jaw with 125 tons of force to grip the pile. Clamping and un-clamping occurs in a few seconds.

### D. POWER UNIT

The Model 325 power unit for the Model 416L vibrator is powered by a Caterpillar 3306TA diesel engine. The diesel engine develops 325 HP at 2100 RPM, which drives 3 hydraulic pumps that create the hydraulic pressures to operate the 416L vibrator motors and hydraulic clamp.

The totally enclosed power unit is mounted on a skid-type fuel tank sub-base. A Control panel at the side of the unit contain all operating gages and controls. A common reservoir supplies hydraulic fluid to three separate hydraulic pumps - two for the vibrator motors and one for the hydraulic clamp.

Three hydraulic hoses, 100 feet in length, connect the power unit to the hydraulic motors on the vibrator. Two other hydraulic hoses run from the power unit to the hydraulic clamp.

I. GENERAL DESCRIPTION

E. REMOTE-CONTROL PENDANT

The vibrator is operated by a hand-held remote control pendant. The pendant has three, two-way switches and two push buttons, (one with a light). One switch (SLOW-FAST) raises and lowers the diesel engine speed. The second switch (REVERSE-FORWARD) starts and stops the vibrator. The other switch (OPEN-CLOSE) operates the hydraulic clamp. The light indicates that adequate clamping pressure exists for vibration to begin. The (red mushroom) push button (EMERGENCY STOP) shuts down the diesel engine instantly, in the event of an emergency. Note: Controls are duplicated on the control panel in case the pendant is damaged. (See pg.III-5, Section E-e)

F. SPECIFICATIONS

1. Constant improvement and engineering progress make it necessary that we reserve the right to make specification changes without notice.

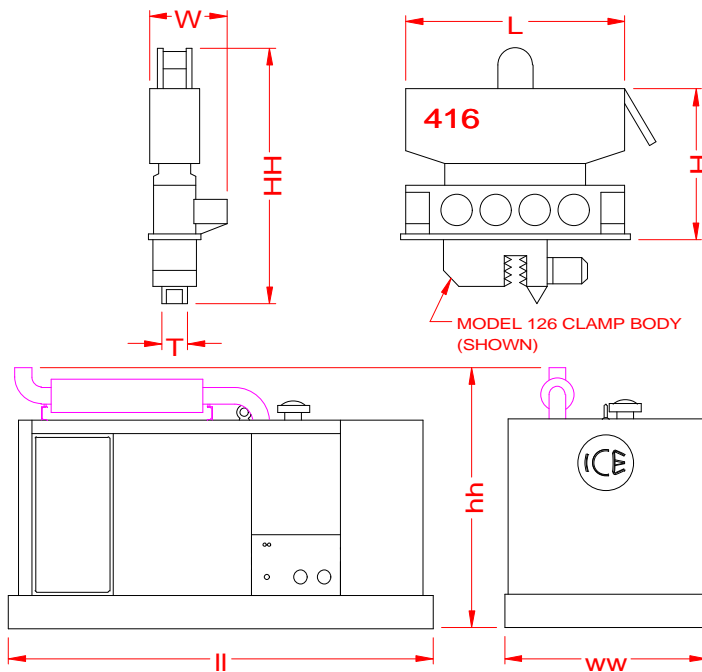

2. MODEL 416L VIBRATOR  
(with hydraulic clamp)

Type.....Hydraulic  
Eccentric Moment...2200 In-lbs.  
Frequency.....760-1600 VPM  
Amplitude.....1/4"-1"Max.  
Pile Clamping Force....125 Tons  
Max. Line Pull for  
Extraction.....40 Tons  
Suspended Weight with .....126  
Clamp.....9,975 lbs.  
Length [L].....95 in.  
Width [W].....17 in.  
Throat Width [T].....14 in.  
Height with Clamp [HH]...101  
in.  
Height without clamp [H]...72 in.

3. MODEL 325 POWER UNIT

Type.....Diesel  
Engine.....CAT 3306TA  
Horsepower (2100 RPM)....325  
Weight.....10,485 lbs.  
Length [II].....126in.  
Width [ww].....60 in.  
Height [hh].....75 in.

## II. PREPARATION FOR OPERATION

### A. GENERAL

When unloading and unpacking the vibratory driver, use extreme care. For your protection, make a thorough inspection of the unit immediately on delivery. In case of any damage or shortage, notify the transit agent at once and have the delivering carrier make a notation on the freight bill.

### B. SAFETY PRECAUTIONS

Safety is basically common sense. There are standard safety rules, but each situation has its own peculiarities which can not always be covered by rules. Therefore, your experience and common sense will be your best guide to safety. Be ever watchful for safety hazards and correct deficiencies promptly.

Use the following safety precautions as a general guide to safe operations:

1. When operating in a closed area, pipe exhaust fumes outside. Continued breathing of exhaust fumes may be fatal.
2. When servicing batteries, do not smoke or use an open flame in the vicinity. Batteries generate explosive gas during charging. There must be proper ventilation when charging batteries.
3. When filling fuel tank, do not smoke or use open flame in the vicinity.
4. Be extremely careful when using a carbon tetrachloride fire extinguisher in a closed area as it produces toxic vapor. Provide adequate ventilation before entering a closed area where carbon tetrachloride has been used.
5. Never adjust or repair the unit while it is in operation.
6. Never operate the diesel engine with the governor linkage disconnected to control the fuel rack.
7. Remove all tools and electrical cords before starting.
8. Store oily rags in containers.
9. Never store flammable liquids near the engine.

**REMEMBER, SAFETY IS EVERYONE'S BUSINESS.**

## II. PREPARATION FOR OPERATION

### C. RIGGING OF VIBRATOR

A steel wire rope sling must be connected to the lifting pin of the vibration suppressor. The required strength of this sling depends on the capacity of the crane and the work to be carried out. A safety factor of five is recommended. Several turns of a smaller diameter cable will usually last longer than one turn of a larger diameter cable.

### D. CONNECTION OF HYDRAULIC CLAMP

The vibrator is usually shipped with the hydraulic clamp already attached.

If the clamp is not attached, it will be necessary to attach it to the bottom of the vibrator. Orient the clamp to the vibrator with the clamp cylinder end (movable jaw) at the same end of the vibrator as the hose chute is mounted. All eight (1.5-6UNC x 5.00) bolts must be in place and torqued to approximately 2800 ft-lbs.

For caisson work, the caisson beam must be attached to the bottom of the vibrator and tightened as above. Then slide the clamps into position on the caisson beam.

## II. PREPARATION FOR OPERATION

### E. CONNECTION OF HYDRAULIC HOSES

#### 1. Connection of hoses at power unit.

- a. The vibrator and hydraulic clamp are connected to the power unit by five hydraulic hoses (Fig. 1) on the next page.

CAUTION: The power unit must be shut down during connection of the hydraulic hoses.

- b. The hoses connect to the power unit with quick-disconnect couplers. Hose couplers are arranged to insure correct connections at the power unit. See the diagram (Fig. 1) for correct hose connection.
- c. Clean couplers with a lint-free cloth before making connections.
- d. Make sure that the couplers are fully run up. They should be fully hand tight. Do not use wrenches to tighten.

#### 2. Connection of hoses at vibrator.

- a. The vibrator is usually shipped with the hoses attached to the vibrator. If the hoses have been shipped separately, they must be connected in the field. Fig. 1 shows the correct arrangement of the five hoses connecting the power unit to the vibrator.

CAUTION: Starting the vibrator with the hoses reversed will result in low power or possible ruptured hoses.

- b. The vibrator is usually shipped with the hydraulic clamp and hoses attached. If the clamp has been shipped separately, the two hoses connecting the clamp to the vibrator must be connected. Fig. 2 on the next page shows the correct arrangement of these hoses.

For caisson clamps, four hoses must be connected. The two 90° fittings on the underside of the hose chute must be removed and replaced by two tees. This allows the four hoses to run to both sides of the vibrator and operate the caisson clamps. The 90° fittings on the top side of the hose chute are stamped O and C (O for Open Clamp on the left side) (C for Close Clamp on the right side).

II. PREPARATION FOR OPERATION

E. CONNECTION OF HYDRAULIC HOSES (CONTINUED)

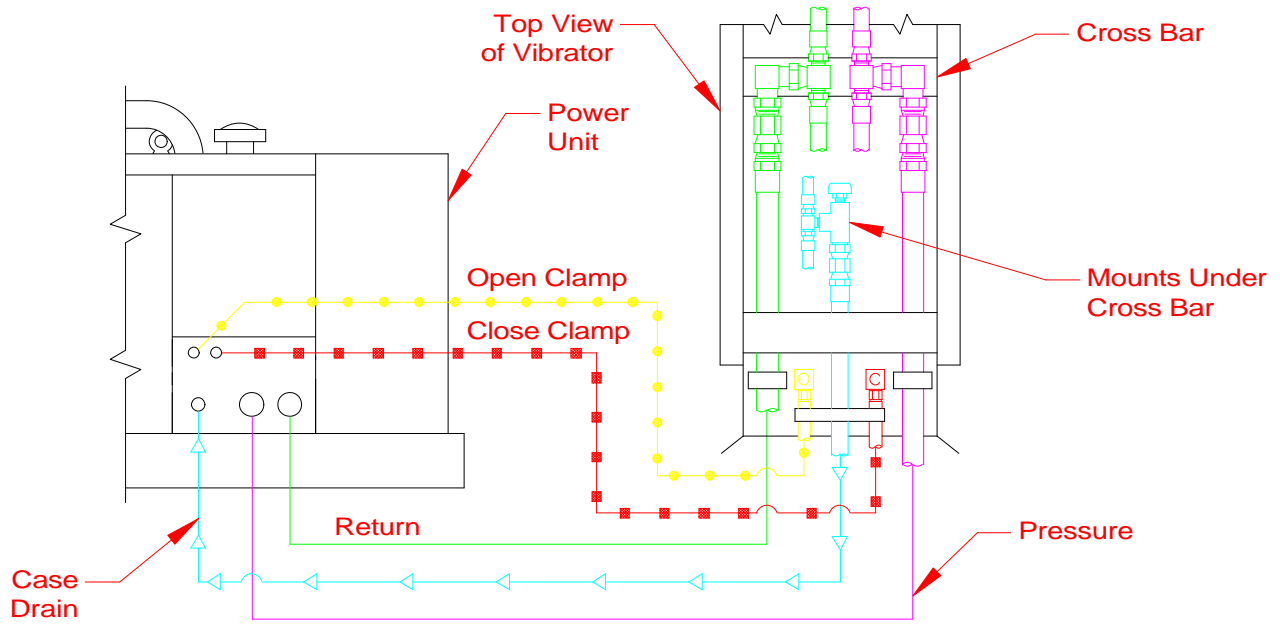

(Fig. 1)

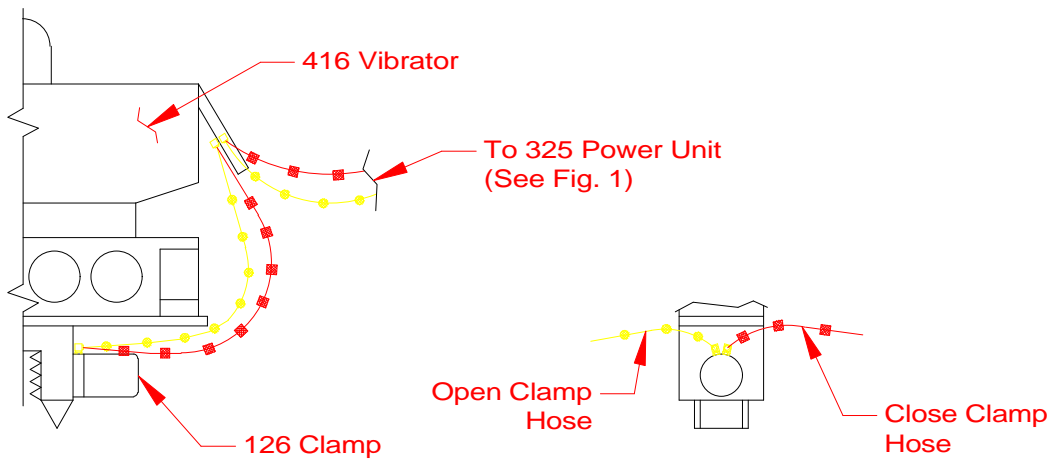

(Fig. 2)

## II. PREPARATION FOR OPERATION

### F. BLEEDING HYDRAULIC CLAMP HOSES

1. When the vibrator and hydraulic clamp are shipped with all hoses attached (between vibrator and clamp and five main hoses connected to the vibrator), the hoses are usually full of fluid and may be used immediately. However, if any of the clamp hoses are connected at the jobsite or if air is present in hoses, they must be bled prior to operation.
2. Read SECTION III - OPERATING INSTRUCTIONS.
3. Start and warm up the diesel engine in accordance with SECTION III-C - STARTING AND WARMING UP ENGINE.
4. With the engine warmed-up and running at 1500 RPM, loosen the close-clamp line at the hydraulic clamp. Turn the clamp switch on the remote-control pendant to CLOSE. Wait until fluid flows from the connection at the hydraulic clamp. When fluid flows without air, tighten the connection.
5. After the line has been bled, alternately turn the clamp switch to CLOSE and OPEN to insure that the clamp is working properly. It may be necessary to bleed the line more than once. The open-clamp line may also require bleeding.

### G. FILLING VIBRATOR PRESSURE HOSE

1. The vibrator is usually shipped with the vibrator hydraulic hoses full of fluid and the unit may be used immediately. However, if the pressure hose has been removed from the vibrator, the hose should be allowed to fill with hydraulic fluid prior to full speed operation.
2. Read SECTION III - OPERATING INSTRUCTIONS.
3. Start and warm up the diesel engine in accordance with SECTION III-C - STARTING AND WARMING UP ENGINE. Hold the vibrator in a vertical position.
4. With the engine warmed up and running at 1000 RPM, turn and hold the vibrator switch REVERSE. The hoses will fill in approximately 5 minutes. CAUTION: If vibration begins in the vibrator, stop immediately and recheck hose connections.





### III. OPERATING INSTRUCTIONS

#### CONTROL PANEL WITH REMOTE CONTROL-PENDANT

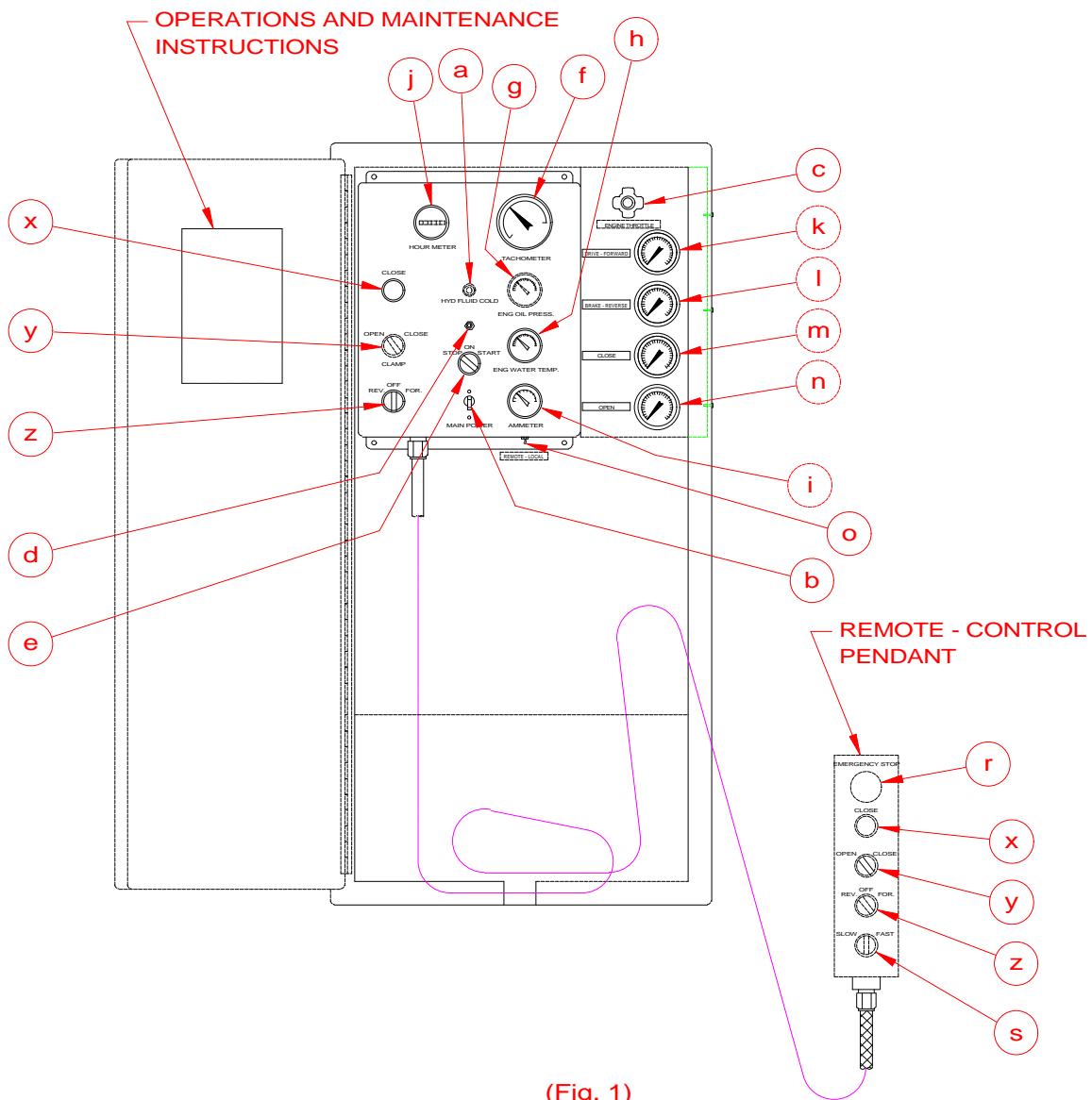

(Fig. 1)

### III. OPERATING INSTRUCTIONS

#### A. COMPLETION OF SET-UP AND MAINTENANCE

1. Complete all preparation as described in Section II.
2. Read Section IV - MAINTENANCE AND ADJUSTMENTS and perform any required maintenance.

#### B. CONTROL PANEL

1. The control box (Fig. 1, page III-1) at the side of the power pack contains the controls and gages for the diesel engine, vibrator, and the OPERATION AND MAINTENANCE INSTRUCTIONS.
2. Control panel contains the following controls and gages:
  - a. Hydraulic fluid cold light - comes on if hydraulic fluid is below 60°F (16°C).
  - b. Main power switch (Circuit Breaker) - on/off switch for 24 volt electrical power. Must be "ON" for the vibrator to run.
  - c. Engine throttle.
  - d. Engine shut-down reset button - on start must be held in until oil pressure exceeds 30 PSI.
  - e. Engine "ON/OFF/START" switch - for diesel engine.
  - f. Engine tachometer.
  - g. Engine oil pressure gage.
  - h. Engine water temperature gage.
  - i. Engine ammeter.
  - j. Engine hourmeter.
  - k. Pressure gage - (Drive - Forward).
  - l. Pressure gage - (Brake - Reverse).
  - m. Pressure gage - (Close).
  - n. Pressure gage - (Open).
  - o. Remote-Local switch.
  - r. Emergency Stop - Push to stop engine
  - s. Electric Throttle
  - x. Clamp light.
  - y. Clamp switch.
  - z. Vibrator switch.
3. The OPERATION AND MAINTENANCE INSTRUCTIONS on the control panel are there as reminders only. They are not complete and therefore not intended to substitute for a thorough understanding of this Operating Manual.

### C. STARTING AND WARMING UP ENGINE

1. Before starting the engine, read the CATERPILLAR OPERATION GUIDE carefully. Follow the engine starting, operating and maintenance procedures in that manual.
2. The diesel engine should not be started if the temperature of the hydraulic fluid is below 0°F. The temperature may be read on the gage on the hydraulic reservoir. If ambient temperatures below 0°F are anticipated, an immersion heater for the hydraulic fluid is available. Consult ICE for details.
3. The MAIN POWER SWITCH on the control panel should be ON. The vibrator switch (FOR/REV) on the control pendant should be in the neutral position.
4. Pull out the ENGINE THROTTLE about half way. Press the button on the end of the throttle for adjustment.
5. Hold SHUTDOWN RESET button in and turn the ENGINE START switch to START position. If the engine fails to start after 30 seconds of cranking, allow the starter to cool for two minutes before repeating the starting procedure.
6. As the engine starts, release the ENGINE START switch. It will return to the RUN position.
7. Adjust the throttle until the engine is running at 1500 RPM and allow to warm-up for five minutes.
8. Allow the temperature of the hydraulic fluid to come up to at least 30°F before starting vibrator.

### D. WARMING HYDRAULIC FLUID

1. The vibrator should not be operated at full speed if the temperature of the hydraulic fluid is below 60°F. The HYDRAULIC FLUID COLD light on the control panel will be on if fluid temperature is below 60°F. Also check gage on reservoir.
2. If temperature of the hydraulic fluid is below 60°F, set the diesel engine at 1500 RPM and run the vibrator at reduced speed until the temperature of the hydraulic fluid exceeds 60°F. The Hydraulic Fluid Cold light will then go off.

### III. OPERATING INSTRUCTIONS

#### D. WARMING HYDRAULIC FLUID (CONTINUED)

3. When the engine is warmed up and hydraulic fluid temperature is at least 60° F, full speed operation may begin. Adjust the throttle so the engine is running at 2310 RPM unloaded. The engine should maintain about 2100 RPM under load.

CAUTION: Do not operate the vibrator if hydraulic fluid temperature exceeds 160°F as this may damage hydraulic components.

#### E. OPERATION OF REMOTE-CONTROL PENDANT

1. The operation of the vibratory driver is controlled by the remote-control pendant. The pendant is connected to the control cabinet with 50 feet of electrical cable to permit operation from any advantageous position to view the vibrator. (Consult ICE for pendant extensions)

2. The pendant has three, two-way switches, an indicator light and an Emergency Stop button.

- a. To Clamp to Pile:

Position vibratory driver on pile. Turn the clamp switch on the pendant to CLOSE. The CLAMP light on the pendant will come on when the hydraulic clamp has achieved adequate pressure to permit vibration to begin. The light should normally come on in a few seconds.

- b. To Start Vibration:

Turn the vibrator switch to FORWARD.

NOTE: The vibrator switch reads FORWARD/REVERSE instead of START/STOP because the Model 325 power unit also operates ICE earth augers.

CAUTION: Do not turn the switch to FORWARD until the CLAMP light in the pendant comes on, indicating adequate clamping pressure.

- c. To Stop Vibration:

Turn the vibrator switch to OFF.

NOTE: Accidentally turning the switch to REVERSE normally has no effect and will not cause damage.

### III. OPERATING INSTRUCTIONS

#### E. OPERATION OF REMOTE-CONTROL PENDANT (CONTINUED)

d. To Unclamp from Pile:

Turn the CLAMP switch to OPEN to release the hydraulic clamp so that the vibrator can be moved from the pile. Hold the CLAMP switch in the open position until the jaws are fully open.

CAUTION: Do not turn the switch to OPEN until a visual check indicates that vibration has stopped.

e. To change engine speed:

Turn the Throttle switch (SLOW-FAST) to SLOW and the engine speed will decrease. Turn the switch to FAST and the engine speed will increase. Momentarily turning the throttle switch to FAST or SLOW during operations will adjust engine speed, and therefore vibrator speed, to facilitate the desired penetration rate.

f. Emergency stop button:

Push the EMERGENCY STOP button in and all operating functions will cease to operate. Diesel engine and vibrator will stop immediately.

g. If the remote control pendant is damaged or the pendant line is cut, you may still operate the vibrator by using the control switches on the control panel (See Fig. 1 on page III-1 items X, Y, Z). On the lower right bottom of the control panel there is a switch labeled "REMOTE-LOCAL". Turn the switch to LOCAL and the switches on the control panel will be functional, and the Remote Control Pendant will be disabled. Engine speed must be adjusted manually.

#### F. CHANGING FREQUENCY

1. In order to provide maximum flexibility in achieving optimum pile penetration and extraction rates, the frequency of the vibratory driver is adjustable.
2. The frequency can be varied from 760 to 1600 vibrations per minute by changing engine speed. Engine speed is changed with the ENGINE THROTTLE on the control panel or electric throttle switch (SLOW-FAST) on the remote control pendant. Vibrator frequency corresponds to engine speed according to the table shown on the next page:

III. OPERATING INSTRUCTIONS

F. CHANGING FREQUENCY (CONTINUED)

<u>ENGINE RPM</u>	<u>VIBRATOR VPM</u>
2100	1600
2000	1525
1800	1370
1600	1220
1400	1070
1200	910
1000	760

G. SHUT DOWN

1. Stop the vibrator.
2. Allow the diesel engine to run for five minutes at 1500 RPM.
3. Reduce speed to low idle for about thirty seconds.
4. Stop the engine by turning the ENGINE START switch to OFF. (Engine may also be stopped by pushing in the EMERGENCY STOP button on the Remote Control Pendant.)

CAUTION: If the diesel engine is shut down while the vibrator is clamped to a pile, the clamp check valve will keep the vibrator clamped to the pile. However, system leakage could result in a loss of clamp pressure over time. Therefore, it is not recommended to leave the vibrator clamped to a pile when the diesel engine is not running.

## IV. MAINTENANCE AND ADJUSTMENTS

### A. GENERAL

Preventive maintenance includes normal servicing that will keep the vibratory driver, clamp and power unit in peak operating condition and prevent unnecessary trouble from developing. This servicing consists of periodic lubrication and inspection of the moving parts and accessories of the unit.

Lubrication is an essential part of protective maintenance, controlling to a great extent the useful life of the unit. Different lubricants are needed and some components in the unit require more frequent lubrication than others. Therefore, it is important that the instructions regarding types of lubricants and frequency of their applications be closely followed.

To prevent minor irregularities from developing into serious conditions that might involve shut-down and major repair, several other services or inspections are recommended for the same intervals as the periodic lubrications. The purpose of these services or inspections is to assure the uninterrupted operation of the unit.

Thoroughly clean all lubrication fittings, caps, filler and level plugs and their surrounding surfaces before servicing. Prevent dirt from entering with lubricants and coolants. The intervals given in the schedule are based on normal operation. Perform these services, inspections, etc., more often as needed for operation under abnormal or severe conditions.

### B. DAILY

1. Check the entire unit prior to and during set-up each day or at the beginning of each shift.
2. Prior to starting the power unit or at the beginning of each shift, check the following items:
  - a. Visibly inspect all bolts, nuts and screws including the bolts fastening the hydraulic clamp to the vibration case to insure they are tight. **IMPORTANT:** vibration loosens bolts- check carefully.
  - b. Tighten bolts holding gripping jaws in hydraulic clamp.
  - c. Grease plunger in hydraulic clamp with any good multi-purpose grease.
  - d. Check the oil level in the vibration case and add oil if required. The oil level should be in the middle of the sight glass. Change oil if milky or contaminated.
  - e. Check the fluid level in the hydraulic reservoir and refill if necessary. Check oil level, with dipstick, in the multi-pump drive.



#### IV. MAINTENANCE AND ADJUSTMENTS

##### B. DAILY (CONTINUED)

CAUTION: It is absolutely imperative that no dirt or other impurities be permitted to contaminate the hydraulic fluid. Any contamination will drastically shorten the life of the high-pressure hydraulic system.

- f. Visually check all hoses for signs of damage or cuts that might cause hose failure during operation. Be sure all connections are tight, especially the quick-disconnect couplers.
  - g. Visually inspect all suppressor elastomers.
  - h. Electrical components need no maintenance except periodic wiping with a clean, dry, lint-free cloth to remove dust.
  - i. Perform all daily maintenance checks and lubrication indicated in the CATERPILLAR OPERATION GUIDE.
3. After engine start-up, check the following:
    - a. Check all hydraulic hoses for leaks. Make sure they hang freely with no kinks.
    - b. Check pump and all hydraulic manifolds for leaks.
    - c. Check the filter indicators. 0-17psi = Filter Clean, 18-23psi = Change Filter, 24 + psi = Filter Clogged The return filter on the power pack must be checked with the diesel engine running at full speed.

##### C. 100 HOURS, 500 HOURS AND OTHER

1. Every 100 hours, drain and add new lubricant in the vibration case.
2. After the first 500 hours, drain and replace the lubricant in the multi-pump drive. There after change every six months.
3. Perform all maintenance checks and lubrication indicated in the CATERPILLAR OPERATION GUIDE.

##### D. ANNUALLY

Have the hydraulic fluid tested by a local hydraulic service center or oil company. Replace if required.

NOTE: The frequency with which hydraulic fluid requires changing depends both on the condition of the fluid and the operating conditions involved. The most accurate method for determining how often fluid should be changed is to have a laboratory fluid analysis done periodically.

#### IV. MAINTENANCE AND ADJUSTMENTS

##### E. SEVERE CONDITIONS

The servicing intervals specified are based on normal operating conditions. Operation under severe or unusual conditions will require some adjustments in servicing intervals.

1. When the average temperature is above 80°F or below -10°F, reduce service time intervals by one-half of those specified above.
2. When operating in the presence of dust or sand, reduce service time intervals by one-half of those specified.
3. When operating in excess of twelve hours per day, reduce service time intervals by one-half of those specified.
4. When operating in air with high salt or moisture, the servicing intervals need not usually be changed. However, the unit should be inspected weekly to determine if additional servicing be required. Also, have hydraulic fluid tested quarterly.
5. For extended inactive periods, the engine should be started at least once a week and run until thoroughly warm. Servicing time intervals may be extended from those specified, but for actual time intervals, contact you local Caterpillar dealer, especially during lengthy storage periods.

##### F. LUBRICATION

1. Crankcase (Diesel Engine)
  - a. Follow the engine manufacturer's maintenance schedule and the lubricating oil specifications outlined in the CATERPILLAR OPERATION GUIDE.
  - b. The lubricant shall meet the performance requirements of API Service Classifications CD or MIL-L-2104C.
  - c. New engines are shipped with ASHLAND 400M + HDT 15W-40 but the following multi-grade crankcase oils are recommended for use or replacement in normal operation (10°F to 90°F) (-12°C to 32°C).

#### IV. MAINTENANCE AND ADJUSTMENTS

##### F. LUBRICATION (CONTINUED)

AMOCO	- 15W-40	300
ARCO	- 15W-40	Fleet S3 Plus
BORON (BP)	- 15W-40	Vanellus C Extra
CHEVRON	- 15W-40	Delo 400
CITGO	- 15W-40	C500 Plus
CONOCO	- 15W-40	Fleet Supreme
EXXON	- 15W-40	XD3
GULF	- 15W-40	Super Duty Plus
MOBIL	- 15W-40	Delvac Super
PHILLIPS	- 15W-40	Super HD II
SHELL	- 15W-40	Rotella T
SUN	- 15W-40	Sunfleet Super C
TEXACO	- 15W-40	Ursa Super Plus
UNION	- 15W-40	Guardol
VALVOLINE	- 15W-40	All Fleet

- d. For operation in extreme sub-zero climate, refer to the CATERPILLAR OPERATION GUIDE Crankcase Lubricating Oils or contact the nearest Caterpillar representative.

#### 2. Hydraulic System

To maintain the maximum operating efficiency in the precision parts of the hydraulic system, it is extremely important to eliminate factors which can cause breakdowns or unsatisfactory performance in the system. Among the most common of these factors are rust, corrosion, contamination and products of oil deterioration. Most problems can be minimized or avoided simply by maintaining a disciplined preventive maintenance program.

Some simple steps to follow as part of that program are:

- a. Keep stored oil dry and clean at all times and always store in clean containers.
- b. Always clean tools, spouts, lids, funnels, etc. when used in conjunction with the transfer of oil.
- c. Never put dirty oil into the hydraulic system. Use only clean, uncontaminated oil of the types recommended below. Never return to the system any fluid which has leaked out.  
NOTE: Foreign material in the hydraulic system can drastically effect the life and operation of many hydraulic component parts.
- d. Clean or replace filter elements at the first indication that they are dirty or ineffective.

IV. MAINTENANCE AND ADJUSTMENTS

F. LUBRICATION (CONTINUED)

Mixing of different manufacturers' hydraulic fluid is not recommended. However, it can be done if the fluids are miscible (contain the same base and additive). It may be necessary to contact an oil supplier to determine this.

New power units are shipped with CHEVRON Clarity AW46 hydraulic oil. This oil exceeds the requirements of both the E.P.A. and U.S. Fish and Wildlife Service for non-toxicity and is inherently biodegradable. Adding any other oil from the list below, will contaminate the Clarity oil and the system will no longer be environmentally friendly.

Should the customer choose to use an alternate oil, the following recommendations may be used when replacing fluid in the hydraulic system.

FIRST Preference Group:

CHEVRON	Clarity AW46
MOBIL	DTE-15
SUN	2105

SECOND Preference Group:

ARCO	Duro AW46
CHEVRON	Hydraulic AW46
PHILLIPS	Magnus A46
SHELL	Tellus 46

THIRD Preference Group:

BORON	Energol HLP46
CITGO	A.W. Hydraulic 46
CONOCO	Super 46
EXXON	Nuto H46
GULF	Harmony 46AW
SUN	Sunvis 846
TEXACO	Rando HD AZ46
UNION	Unax AW46

Whenever fluids from the second preference group are used, it is necessary to test the oil more often to insure that viscosity remains within recommended limits while in service. Using fluids from the third preference group requires even a more discerning inspection than use of fluids from the second group.

The recommended fluids were chosen based on the hydraulic system operating temperature range being 5°F (-15 °C) (cold ambient start-up) to 160°F (71°C) (maximum operating).

## IV. MAINTENANCE AND ADJUSTMENTS

### F. LUBRICATION (CONTINUED)

When operating in arctic conditions, it is recommended to use an immersion heater to pre-heat the oil prior to starting . Contact ICE for other arctic operating procedures. It may also be necessary in extremely cold or hot climates to use a different viscosity oil which is better adapted to adverse conditions. Contact the nearest oil supply representative for suggested procedures.

CHEVRON Clarity AW46 hydraulic fluid is available from ICE in five gallon cans. See SECTION VIII - ORDERING PARTS, page VIII-40.

#### 3. Vibration Case

The fluid level is easily read through the sight glass located at the lower center of the vibration case opposite the motor side. Lubricating oil may be added when necessary, through either of the holes in the vibration case top plate after removing the 1" pipe plugs. To drain the case, remove a 3/4" pipe plug at either end of the base plate. Tilt the case for complete drainage.

#### Multi-Pump Drive Adapter

The fluid level is easily checked by removing the dip stick mounted on the right side of the Multi pump Drive Adapter. Lubricating oil may be added by removing the filler-breather plug from the 90° street ell located on the top center of the Multi-pump drive Adapter. Draining the lubricant may be done by removing the magnetic drain plug on the bottom of the Multi-pump Drive Adapter.

The preferred lubricating oil for ICE vibration cases is "High Moly" oil (Shaffer 268). Longer intervals between fluid changes and fewer maintenance hours spent on mechanical service can generally be realized with this fluid.

Therefore, whenever the "first preferred" oil is not available, or desired, and an alternate fluid is selected, it will be necessary to test and/or change the oil at shorter intervals.

Extensive tests have indicated that the use of Shaffer 268 results in cooler operation and extended bearing and gear life.

IV. MAINTENANCE AND ADJUSTMENTS

F. LUBRICATION (CONTINUED)

- a. The vibration case and multi-pump drive adapter lubricants installed at the factory are SHAFFER 268 but the following gear lubes may be used when changing lubricants:

FIRST Preference Group:

SHAFFER 268

SECOND Preference Group:

MOBIL	SHC-634
BORON	Gearep 140
CHEVRON	Gear Comp. NL460
CITGO	Premium MP 85W-140
CITGO	Standard MP 85W-140
GULF	Lub 85W-140 Lub 85W-140
PHILLIPS	MP 85W-140
SHELL	Omala 460 Omala 460
SUN	Sunep 1110

THIRD Preference Group (Natural Petroleum Base):

AMOCO	Perma Gear EP140
ARCO	Pennant NL 460
CONOCO	EP 460
EXXON	Spartan EP 460
PHILLIPS	AP 140
TEXACO	Meropa 460
UNION	MP 85W-140
VALVOLINE	Gear Lub 85W-140

SHAFFER 268 Lubricant is available from ICE in five gallon cans. See SECTION VIII ORDERING PARTS, page VIII-40

G. CAPACITIES

- |                                 |      |         |
|---------------------------------|------|---------|
| 1. Diesel Engine Crankcase      | 29   | Quarts  |
| 2. Hydraulic System (Reservoir) | 270  | Gallons |
| 3. Vibration Case               | 2.5  | Gallons |
| 4. Fuel Tank Sub-Base (Diesel)  | 130  | Gallons |
| 5. Engine Cooling System        | 56   | Quarts  |
| 6. Multi-Pump Drive Adapter     | 4.25 | Quarts  |

#### IV. MAINTENANCE AND ADJUSTMENTS

##### H. DRAINING AND FILLING HYDRAULIC FLUID RESERVOIR

1. The Hydraulic reservoir is drained by removing a plug on the bottom of the reservoir.
2. The hydraulic reservoir is filled by the manual pump mounted on the back (engine side) of the reservoir. All fluid is pumped to the reservoir through the returned filter (F2) to insure no dirt enters the hydraulic system.

##### I. CHANGING HYDRAULIC RETURN FILTER ELEMENTS

1. The return filters are located on the hydraulic reservoir above the hex key rack.
2. To remove the return filter elements, you must use a filter wrench capable of accepting a 5" diameter filter. (Available at your local auto-parts store.) Unscrew the return filter elements counterclockwise to remove. Remove both filter elements and gaskets from the filter housing.
3. Clean filter housing with a lint free rag.
4. Install the new gaskets to the new filter elements. Apply a light coating of multi-purpose grease to the top of each gasket.
5. Screw the return filter elements and gaskets clockwise onto the filter housing until the gaskets make contact to the filter housing base.
6. Using the filter wrench, tighten both return filter elements approximately 3/4 of a turn.
7. With four new return filter elements installed, start the power unit and run for approximately three minutes. CHECK FOR LEAKS.

IV. MAINTENANCE AND ADJUSTMENTS

J. BOLT TORQUE INFORMATION

Torque, in foot-pounds, is determined by the length of the wrench handle (in feet) multiplied by the weight (or force in pounds) applied at the end of the handle. For example, if the wrench is one foot long and five pounds of force is applied at the end of the handle, the total torque applied would be five foot pounds. A six inch wrench would require ten pounds of force to obtain five foot pounds of torque.

Proper use of the torque wrench is important. To obtain the listed torques, a steady pull should be exerted to the handle until the desired torque is reached.

The following torque specifications apply to the bolts from the vibrator assemblies listed. Whenever any of these bolts, are replaced, the given torque specifications should be adhered to.

<u>VIBRATION SUPPRESSOR</u>		<u>Page VIII-7 &amp; 9</u>	
Item	14, 45	1/2"-13	119 Ft-Lbs
Item	16, 21	5/8"-11	233 Ft-Lbs
Item	6, 17, 20	3/4"-10	417 Ft-Lbs

<u>VIBRATION CASE</u>		<u>Page VIII-11</u>	
Item	3, 12	1/2"-13	119 Ft-Lbs
tem	16	5/8"-11	233 Ft-Lbs

<u>CLAMP BODY</u>		<u>Page VIII-30</u>	
Item 3	1"-8	540 Ft-Lbs	
Item 18	1 -1/2"-6	2800 Ft-Lbs	



V. HYDRAULIC CIRCUITRY (REFERENCE:HYDRAULIC SCHEMATIC PG V-4)

A. HYDRAULIC CLAMP

With the diesel engine running, hydraulic fluid is taken from the reservoir by the clamp pump (P2). The clamp pump flow returns to the reservoir if the clamp switch on the pendant has not been moved.

Turning the clamp switch on the control pendant to CLOSE activates the CLAMP CONTROL VALVE (V1). Hydraulic fluid is directed to the CLOSE CLAMP side of the hydraulic CYLINDER (CYL) in the hydraulic clamp. The clamp closes. Clamping pressure is indicated by the clamp pressure gage (GA-3). When clamping pressure reaches approximately 4200 PSI, the CLAMP PRESSURE SWITCH (PS-1) deactivates the CLAMP CONTROL VALVE (V1), which directs the flow from the clamp pump to the reservoir. Pressure at the clamp is maintained by the CLAMP CHECK VALVE (CV5). If clamping pressure falls below 3900 PSI, the CLAMP PRESSURE SWITCH activates the CLAMP CONTROL VALVE to restore pressure. In the event of hose failure, a second CLAMP CHECK VALVE (CV7), located in the CLAMP CYLINDER, will hold the CLAMP CYLINDER closed.

Turning the clamp switch on the control pendant to OPEN activates the CLAMP CONTROL VALVE (V1). Hydraulic fluid is directed to the OPEN CLAMP side of the hydraulic cylinder. The pressure in the OPEN CLAMP line opens the CLAMP CHECK VALVE (CV5). The clamp opens. Pressure in the OPEN CLAMP line is indicated by the clamp pressure gage (GA-4).

Pressure in the clamping circuit is limited to 4500 PSI by the clamp relief valve (RV2). The quick-disconnect couplers (QD3 & QD4) permit de-coupling of the clamp hoses at the power unit.

NOTE: Clamp pump may also be used to power some auxiliary functions. Contact ICE for information on "POWER BEYOND" modifications.

B. VIBRATOR DRIVE

With the diesel engine running, hydraulic fluid is taken from the reservoir by two DRIVE PUMPS (P1) and directed to the CONTROL MANIFOLD. Fluid pressure opens the cartridges (CA1 and CB1), which vent the hydraulic fluid back to the reservoir through the RETURN FILTER (F2), if the vibrator switch on the pendant has not been moved.

## V. HYDRAULIC CIRCUITRY

### B. VIBRATOR DRIVE (CONTINUED)

Turning the vibrator switch, on the control pendant, to FORWARD activates the FORWARD SOLENOID on the CONTROL VALVE (V2). By blocking the pilot flow from cartridge (CB1 and CA2), the CONTROL VALVE (V2) causes these cartridges to close, thus directing pump flow to the VIBRATOR MOTORS (M).

Full motor speed is reached within a few seconds and the motor drive pressure is indicated by GAGE (GA - 1). Maximum drive pressure is limited to approximately 5000 PSI by the FORWARD RELIEF VALVE (RV1). The FORWARD RELIEF VALVE (RV1), if opened by over pressure, permits a small pilot flow from cartridges (CB1 AND CA2). This pilot flow causes cartridges (CB1 and CA2) to partially open and allows some or all of the pump flow to return to the reservoir. Case drain fluid from the motors returns to the reservoir. Case drain pressure is limited to 50 PSI by the case drain RELIEF VALVE (RV3). Oil returning from the VIBRATOR MOTORS (M) opens cartridge CB2 and returns to the reservoir through COOLER VALVE (V3) and FILTER (F2).

Returning the Vibrator Switch to the center position de-energizes control valve (V2), and again opens cartridges CA1 and CB1 which allows pump flow to return to the reservoir without driving the vibrator. In neutral, CONTROL VALVE, (V2) also blocks pilot flow from cartridges (CA2) and the oil returning from VIBRATOR MOTORS (M). To produce a momentary "Braking" Action. When return oil pressure reaches 1000 PSI, REVERSE RELIEF VALVE (RV4) permits a small pilot flow from cartridge (CB2). This pilot flow allows cartridge (CB2) to partially open and direct motor return flow to the reservoir at 1000 PSI. Cavitation of the VIBRATOR MOTORS (M) is prevented during braking, by CHECK VALVE (CV-6). The "Reverse" position of the vibrator switch is non-functional in the "Vibrator Mode."

Hydraulic fluid temperature is regulated by the COOLER VALVE (V3). When fluid temperature is below 100°F, V3 directs the flow directly to the reservoir through FILTER (F2). When fluid temperature exceeds 100°F, COOLER VALVE (V3) directs flow through the HEAT EXCHANGER (HE) before it enters the reservoir, through FILTER (F2). Excessive pressure in the HEAT EXCHANGER (HE) is prevented by CHECK VALVE (CV-2), which bypasses excess flow and limits pressure to 65 PSI.

The quick-disconnect couplers (QD1, QD2, and QD5) permit de-coupling of the drive and case drain hoses at the power unit.

## V. HYDRAULIC CIRCUITRY

### C. AUGER DRIVE

To convert the 325 Power Unit to operate an ICE, or similar, Bi-Directional Drill open (turn CCW) VIBRO-AUGER valve (V4) fully. Re-adjust RELIEF VALVES (RV-1 & RV4) to forward & reverse pressure specified for Auger, and re-set RELIEF VALVE (RV-2), if necessary, for two speed signal.

See ICE Auger Manuals for description of Hydraulic Control Manifold operation, in the "Auger Mode."

### D. HYDRAULIC IMPACT HAMMER

To convert a 325 Power Unit to operate an ICE Hydraulic Impact Hammer, open (CCW) VIBRO-AUGER valve (V4) fully. Readjust RELIEF VALVE (RV1) to specified pressure, and reset RELIEF VALVE (RV2) for two stroke signal.

See ICE Hydraulic Impact Hammer Manual for complete Impact Hammer set up instructions.

### E. OTHER

Returning fluid is filtered by the RETURN FILTER (F2). INDICATOR GAGE (GA5) shows condition of FILTER (F2).

A manual PUMP (MP) is provided to fill the hydraulic reservoir. A CHECK VALVE (CV4) prevents loss of fluid from the reservoir back through this pump.

A TEMPERATURE SWITCH (TS) located in the reservoir operates the hydraulic fluid cold light.

The HEAT EXCHANGER (HE) cools the hydraulic fluid returning to the reservoir.

Motor cavitation is prevented in the braking operation by the CHECK VALVE (CV6).

Extra Long ACCUMULATOR HOSE (AC) in pilot system expands as pressure increases. The additional pilot flow causes (CA2) to produce a smooth acceleration of VIBRATOR MOTOR (M).

V. HYDRAULIC CIRCUITRY

HYDRAULIC SCHEMATIC

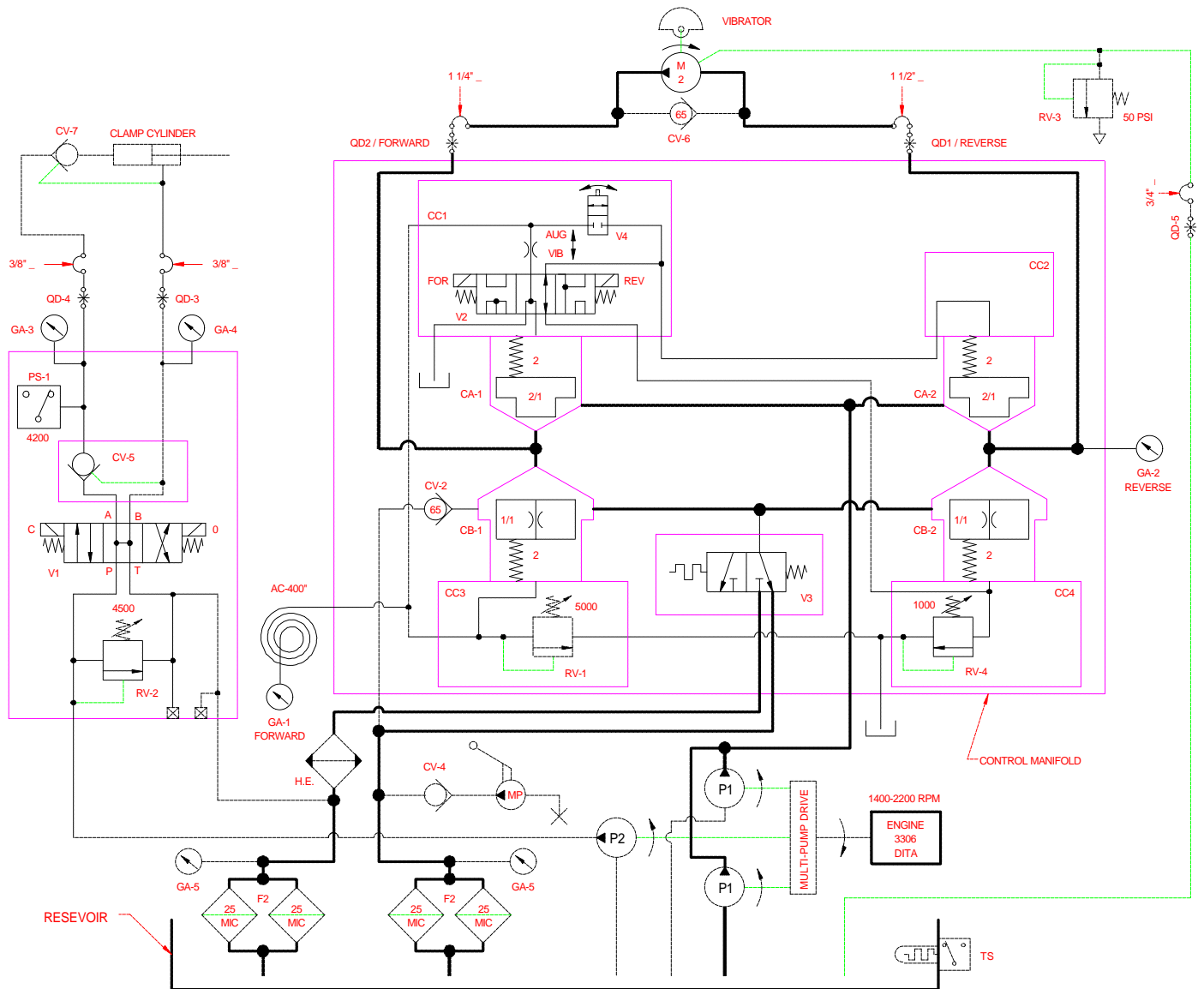

V. HYDRAULIC CIRCUITRY

F. HYDRAULIC COMPONENTS LIST

Notation	Description	Part Number	Page Ref.
AC	Accumulator Hose	110680	VIIV-25
CA1 & 2	Cartridge A (2)	110624	VIII-27
CB1 & 2	Cartridge B (2)	110622	VIII-27
CC1	Cartridge Cover	110530	VIII-27
CC2	Cartridge Cover	110606	VIII-27
CC3	Cartridge Cover	110546	VIII-27
CC4	Cartridge Cover	110544	VIII-27
CV2	Check Valve	130339	VIII-27
CV4	Manual Pump Check Valve	100451	VIII-19
CV5	Clamp Check Valve	110149	VIII-29
CV6	Check Valve - Vibrator	100800	VIII-7
CV7	Check Valve - Clamp Cylinder	120629	VIII-31
E	Diesel Engine	100508	VIII-17
F2	Return Filter	100518	VIII-17
GA-1	Forward Pressure Gage	110600	VIII-25
GA-2	Reverse Pressure Gage	110600	VIII-25
GA-3	Close Clamp Pressure Gage	110600	VIII-25
GA-4	Open Clamp Pressure Gage	110600	VIII-25
GA-5	Filter Indicator Gage	100436	VIII-21
HE	Heat Exchange	400099	VIII-17
M	Motor	100779	VIII-11
MP	Manual Pump	100447	VIII-19
P1	Drive Pumps (2)	100510	VIII-17
P2	Clamp Pump	100684	VIII-17
PS-1	Clamp Pressure Switch	100627	VIII-29
QD1	Vibrator Reverse Disconnect	110690	VIII-17
QD2	Vibrator Forward Disconnect	110692	VIII-17
QD3	Clamp Open Disconnect	100777	VIII-20
QD4	Clamp Close Disconnect	100245	VIII-20
QD5	Case Drain Disconnect	400095	VIII-17
RV1	Forward Relief Valve	100632	VIII-27
RV2	Clamp Relief Valve	100898	VIII-29
RV3	Case Drain Relief Valve	100032	VIII-7
RV4	Reverse Relief Valve	100630	VIII-27
TS	Temperature Switch	400115	VIII-20
VI	Clamp Control Valve	110147	VIII-29
V2	Control Valve	810519	VIII-27
V3	Cooler Valve	110628	VIII-27
V4	Vibro-Auger Valve	100654	VIII-27

## VI. ELECTRIC CIRCUITRY (REFERENCE:ELECTRICAL SCHEMATIC PG VI-3)

### A. DIESEL ENGINE

The BATTERIES provides 24-volt current to start the diesel engine. In order to start the diesel engine, the circuit breaker (MAIN POWER) switch should be ON and the vibrator switch (REV-FOR) on the remote control pendant should be in the neutral position. This insures that the vibrator will not begin vibrating when the engine starts. Turning the ENGINE START SWITCH to START energizes the START RELAY which energizes the START MOTOR and turns over the diesel engine. If fuel is available, the diesel engine will start. In order for fuel to be available to the engine, the shutdown reset must be closed (pushed in) to energize the FUEL SOLENOID. The FUEL SOLENOID opens the injector pump and allow fuel to flow to the engine. With the diesel engine running, the AMMETER indicates charging amperes. The HOUR METER indicates engine operating hours. A TACHOMETER indicates engine speed.

A system of safety controls shut off the fuel supply, which stops the diesel engine in the event that engine water temperature is too high or engine oil pressure is too low. The heart of the safety system is the shutdown reset, which is normally closed, thereby providing current to operate the HOUR METER and to energize the FUEL SOLENOID. Energizing the fuel solenoid opens the injector pump and allows fuel to flow to the diesel engine. The shutdown reset must remain closed so that fuel continues to flow to the diesel engine.

If the coil in the shutdown reset is energized, the shutdown reset will open, shutting off the fuel to the diesel engine. The engine will stop. The coil may be energized by either of the following devices:

1. ENGINE OIL PRESSURE GAGE - If oil pressure is below 15 PSI, contacts in the gage will be closed providing current to energize the shutdown reset coil. On start-up, the reset button of the shutdown reset (on the control panel) must be held in until oil pressure exceeds 30 PSI.
2. ENGINE WATER TEMPERATURE GAGE - If water temperature exceeds 210°F, the contacts of the gage will close energizing the shutdown reset coil.
3. Pushing the EMERGENCY STOP BUTTON on Remote Control Pendant energizes the shutdown reset coil.

The diesel engine is stopped by turning the ENGINE START SWITCH to OFF. This will de-energize the FUEL SOLENOID shutting off the fuel to the engine.

## VI. ELECTRICAL CIRCUITRY

### B. HYDRAULIC CLAMP

With the diesel engine running, turning the clamp switch (OPEN-CLOSE), on the control pendant to CLOSE energizes the close-clamp solenoid (CLOSE-SOL.). This operates the clamp control hydraulic valve and closes the clamp.

When the pressure in the close-clamp hydraulic circuit reaches 4200 PSI, the pressure switch (PS-1) opens and de-energizes the close-clamp solenoid and turns on the CLAMP LIGHTS on the control pendant and control panel. If close-clamp pressure falls below 3900 PSI, the pressure switch closes and re-energizes the close-clamp solenoid to rebuild pressure. The CLAMP LIGHTS go out. When pressure returns to 4200 PSI, The pressure switch opens de-energizing the close-clamp solenoid and turns on the CLAMP LIGHTS.

With the diesel engine running, turning the clamp switch (OPEN-CLOSE) to OPEN energizes the open-clamp solenoid (OPEN SOL.). The clamp opens.

### C. VIBRATOR

With the diesel engine running, turning the vibrator switch on the control pendant to the FORWARD position energizes the forward SOLENOID on the control valve (V2). The control valve directs hydraulic fluid to the hydraulic motors and the vibrator starts.

With the diesel engine running, turning the vibrator switch on the control pendant to the center position de-energizes the forward SOLENOID. Fluid no longer is directed to the motor and they stop.

### D. OTHER

With the MAIN POWER switch ON, the TEMPERATURE SWITCH turns on the HYDRAULIC FLUID COLD LIGHT if the temperature of the hydraulic fluid in the reservoir is below 60°F. At 60°F or above, the TEMPERATURE SWITCH turns off the HYDRAULIC FLUID COLD LIGHT.

Duplicate vibrator and clamp switches are located on the control pendant and on the control panel. Turning the LOCAL-REMOTE switch to LOCAL activates only the clamp and vibrator switches located on the control panel. Turning the LOCAL-REMOTE switch to REMOTE only permits operation of the clamp and vibrator from the control pendant.

# VI. ELECTRICAL CIRCUITRY

# ELECTRICAL SCHEMATIC

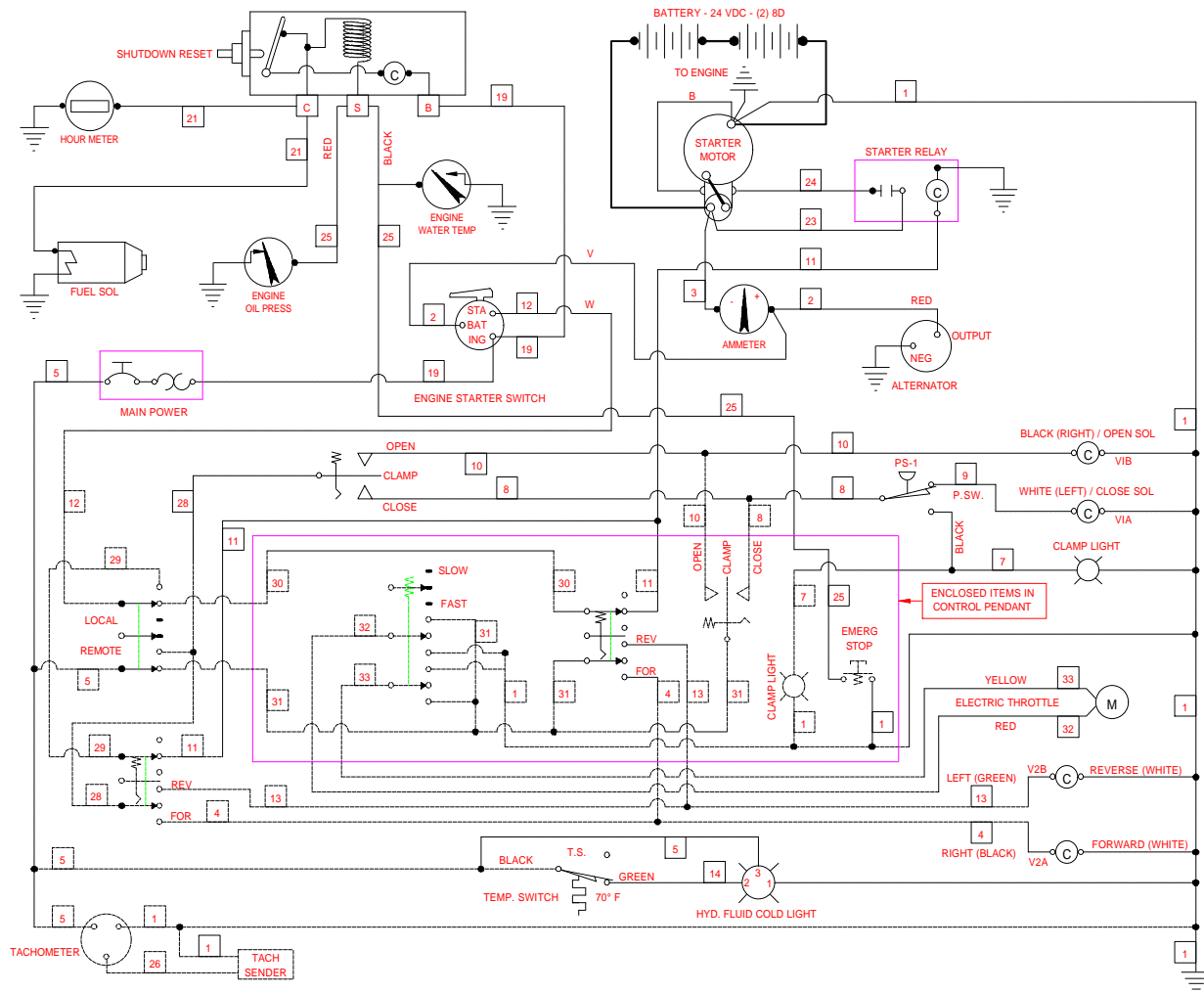



## VI. ELECTRICAL CIRCUITRY

### E. ELECTRICAL COMPONENTS LIST

Notation	Reference	Part Number	Page Ref.
ALTERNATOR	Alternator	See Cat. Parts Book	
AMMETER	Ammeter	110371	VIII-23
BATTERY	24-Volt Battery	400890	VIII-17
CLAMP LIGHT (2)	Clamp Light	100359	VIII-25
ENG. START SW.	Engine Start Switch	130259	VIII-25
FOR/REV (2)	Vibrator Switch (FWD/REV)	130155	VIII-25
FUEL SOL.	Fuel Solenoid Valve	See Cat. Parts Book	
HOUR METER	Hour Meter	100343	VIII-23
HYD. FLUID COLD	Hyd.Fluid Warning Light	100355	VIII-23
LOCAL-REMOTE	Local-Remote Switch	140361	VIII-25
MAIN POWER	Main Power Circuit Breaker	400141	VIII-23
OIL PRESSURE	Oil Pressure Gage	100329	VIII-23
OPEN/CLOSE (2)	Clamp Switch (OPEN/CLOSE)	130155	VIII-23
PS-1	Pressure Switch	100627	VIII-29
STARTER MOTOR	Engine Starter	See Cat.Parts Book	
START RELAY	Engine Start Relay Switch	See Cat.Parts Book	
SHUTDOWN RESET	Shutdown Reset	130257	VIII-25
TACH	Tachometer	See Cat.Parts Book	
TACH SENDER	Tachometer Sender	See Cat.Parts Book	
TEMP. SWITCH	Temperature Switch	400115	VIII-20
V1A	Close-Clamp Solenoid (Valve)	110147	VIII-29
V1B	Open-Clamp Solenoid (Valve)	110147	VIII-29
V2A	Forward Solenoid (Valve)	810519	VIII-27
V2B	Reverse Solenoid (Valve)	810519	VIII-27
WATER TEMP.	Water Temperature Gage	130251	VIII-23
EMERGENCY STOP	Emergency Stop Button	130507	VIII-25
SLOW-FAST	Engine Throttle Switch	130509	VIII-25

# VI. ELECTRICAL CIRCUITRY

# ELECTRICAL DIAGRAM

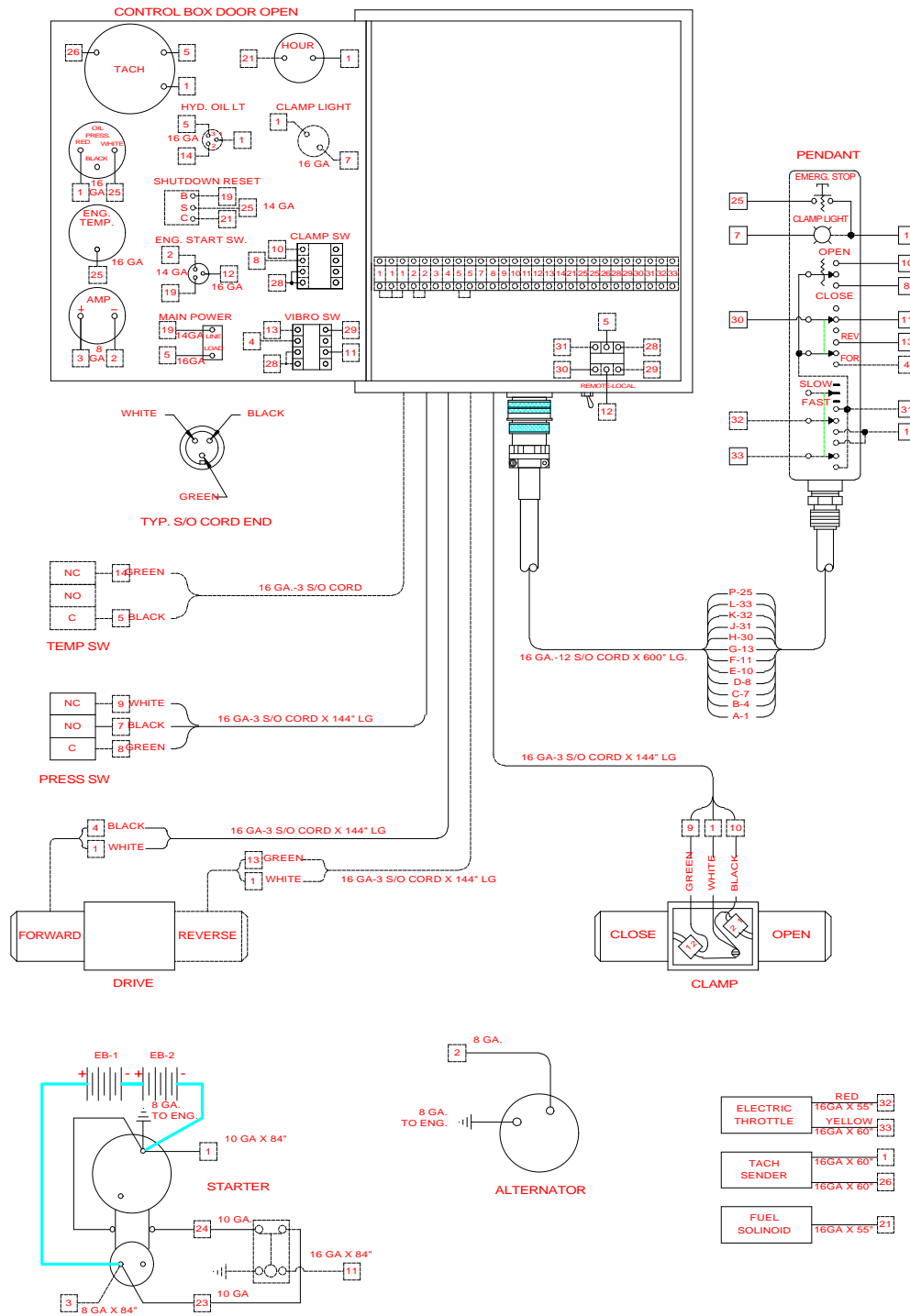



## VII. GENERAL DATA

### C. SERIAL NUMBER LOCATIONS

1. The following ICE vibratory units are serial numbered separately:
  - a. Vibrator
  - b. Power unit
  - c. Piling Clamps
  - d. Caisson beams
  - e. 90 deg. clamp adapter
  
2. In addition to the serial number plate itself (on vibrators, power units and clamps), the serial number is stamped into each unit in one or more places as follows:
  - a. Vibrator stamped twice - once on top right side of suppressor housing, once on bottom lip of vibration case on right side of motors' side.
  - b. Power unit stamped twice - once on control panel side of unit at right corner of reservoir, once on sub-base inside door below hex-key rack.
  - c. Model 126B universal clamp is stamped three times - once between cylinder and pile guide, once above the grease fitting, and once on the flange of the cylinder housing.
  - d. Model 127 Z-Pile clamp stamped twice- once in front of cylinder guard, once in back opening of pile guide.
  - e. Model 80 caisson clamp stamped twice - once by the lifting eye, once by the adjusting screw.
  - f. Caisson beam is stamped three times- once on top center, once in center of both sides of flange.
  - g. 90 deg. clamp plate stamped twice - once on top center, once on side.

## VIII. ORDERING PARTS

### A. PROCEDURE

1. When ordering parts, be sure to include the model and serial number of the unit or component. The serial number may be located by referring to SECTION VII, SERIAL NUMBER LOCATION. Confirm all telephone orders immediately to avoid duplicating shipment.
2. ORIGINAL EQUIPMENT; Where component serial numbers are given, these apply only to equipment and components originally furnished with the unit. Where equipment has been changed or upgraded these numbers may not be an adequate description.
3. SHIPMENT; State to whom shipment is to be made and method of shipment desired, otherwise our own judgement will be used.
4. SHORTAGES; Claims for shortages or errors should be made immediately upon receipt of parts. No responsibility will be assumed for delay, damage or loss of material while in transit. Broken, damaged or lost material should be refused or a full description made of damage or loss to the carrier agent on the freight or express bill.
5. RETURN OF PARTS; If for any reason you desire to return parts to the factory or to any distributor from whom these parts were obtained, you must first secure permission to return the parts. Shipping instructions will be given along with this permission. A ten percent handling charge must be assessed against the returned shipment unless an error is made by the factory or by the distributor when filling your order.

VIII. ORDERING PARTS

B. FITTING DESCRIPTION KEY

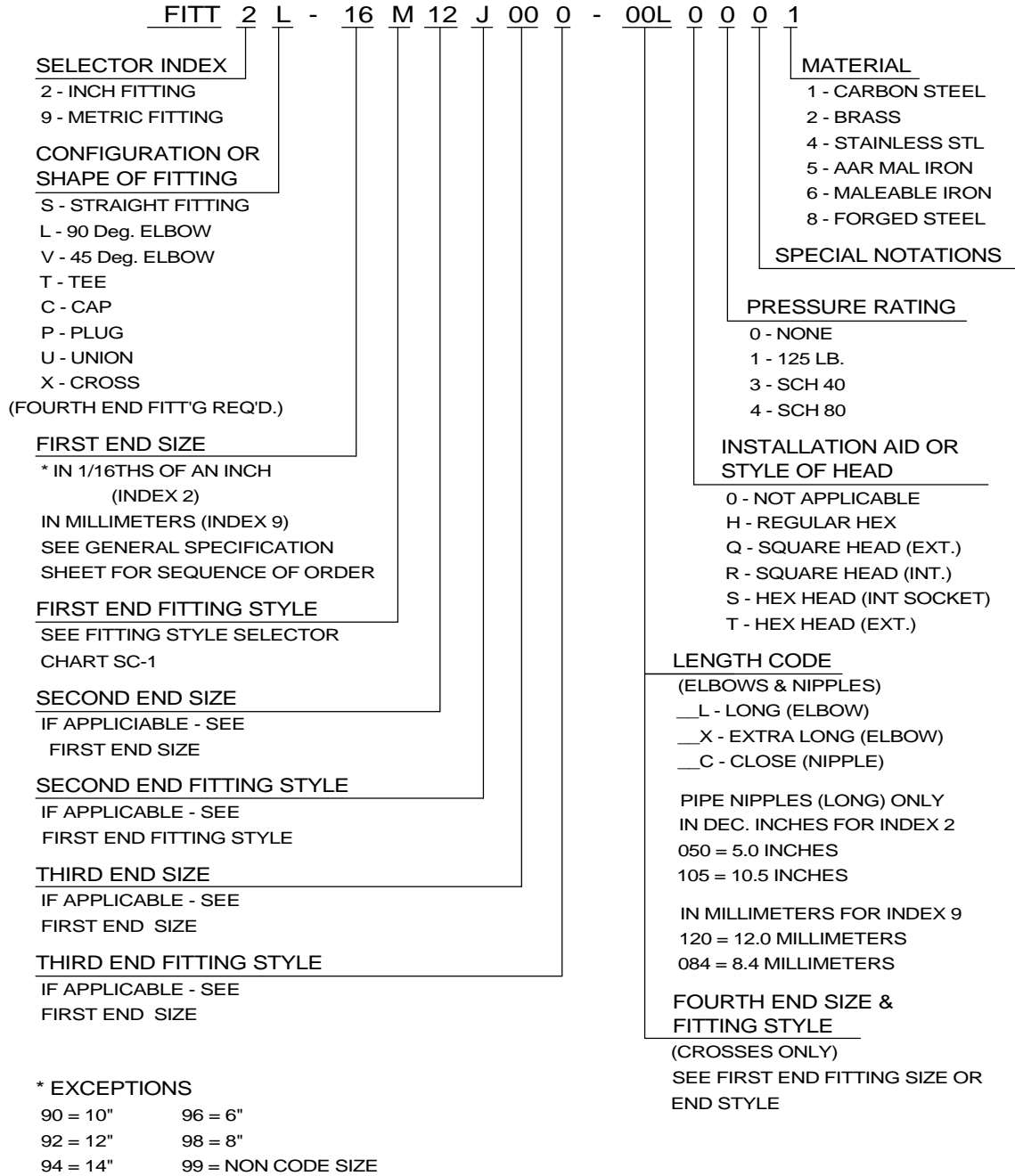

VIII. ORDERING PARTS

B. FITTING DESCRIPTION KEY (CONTINUED)

FITTING STYLE SELECTOR CHART

SC-1

FOR END FITTING STYLE SELECTION

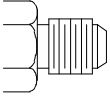
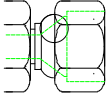
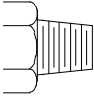
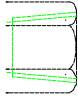
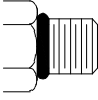
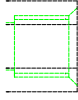
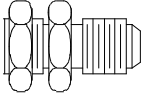
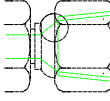
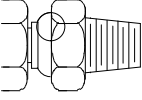
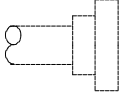
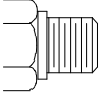
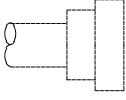
<b>M</b>		JIC MALE 37 Deg. FLARE	<b>J</b>		JIC FEMALE 37 Deg. FLARE (& SWIVEL)
<b>P</b>		MALE PIPE NPT	<b>Q</b>		FEMALE PIPE NPTF
<b>R</b>		S.A.E. MALE O-RING (& ADJUSTABLE)	<b>K</b>		S.A.E. FEMALE O-RING
<b>B</b>		JIC MALE 37 Deg. FLARE BULKHEAD	<b>N</b>		FEMALE PIPE NPSM-SWIVEL
<b>D</b>		MALE PIPE NPT SWIVEL	<b>F</b>		SPLIT FLANGE 3000 PSI. CODE 61
<b>S</b>		B.S.P. MALE PIPE	<b>H</b>		SPLIT FLANGE 6000 PSI. CODE 62

VIII. ORDERING PARTS

C. HOSE DESCRIPTION CODE

The HOSE DESCRIPTION CODE is a 24 digit number enabling easier and quicker identification whenever a hose replacement is desired. The key below explains the structure of the coded number in detail.

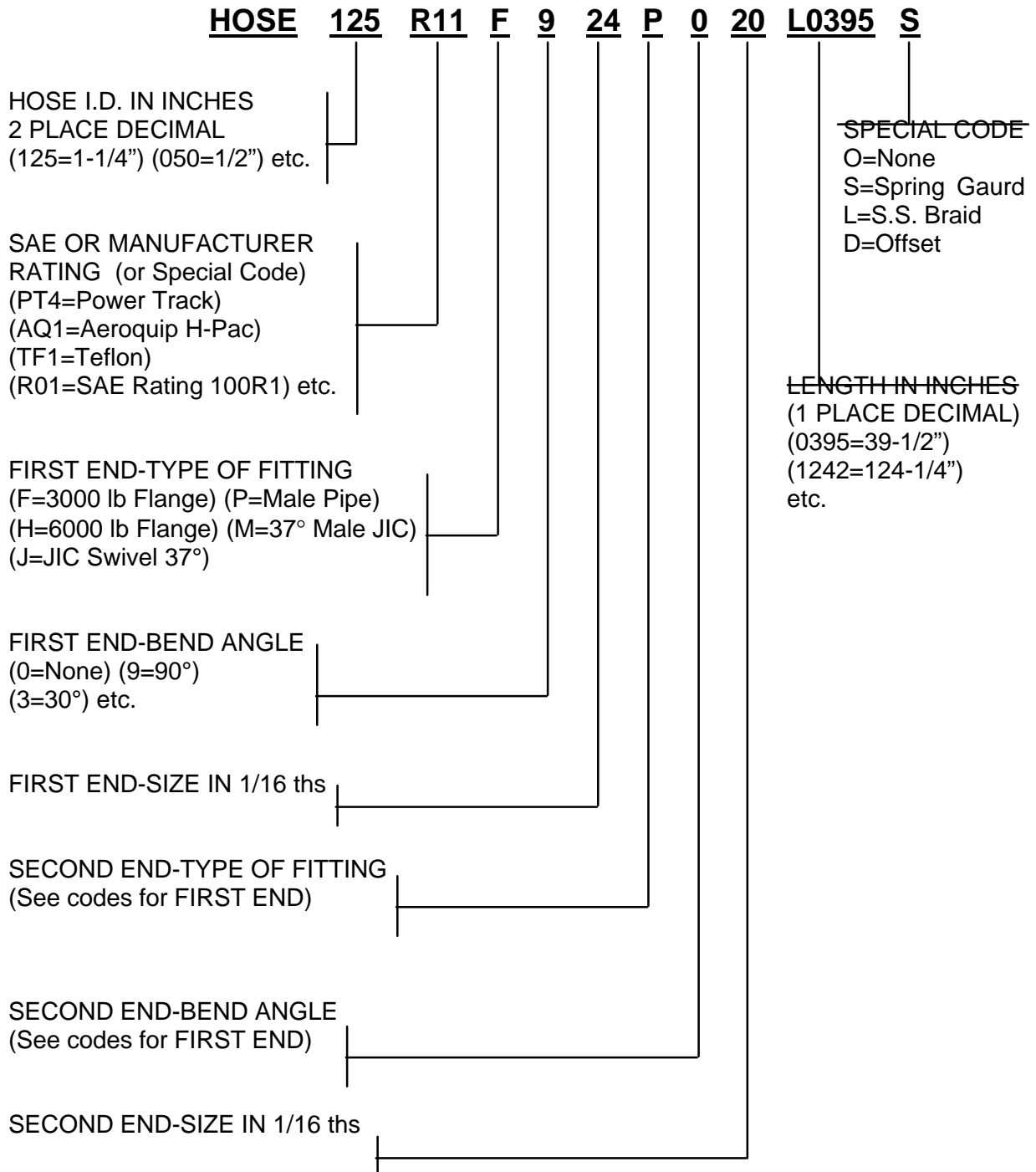



## VIII. ORDERING PARTS

### D. PARTS IDENTIFICATION

1. Parts lists and drawings are included on the following pages for the equipment components shown below:

a. VIBRATION SUPPRESSOR	800027
b. VIBRATION CASE	810037
c. HOSE ASSEMBLIES -INTERCONNECTING	800029
d. POWER UNIT - ENCLOSURE	800379
e. POWER UNIT - INTERNAL	800377
f. CONTROL BOX	810585
g. CONTROL MANIFOLD ASSEMBLY	810571
h. CLAMP MANIFOLD	810449
i. MODEL 126B CLAMP	800327
j. MODEL 127 Z-PILE CLAMP	800041
k. MODEL 80B CAISSON CLAMP	800047
l. CAISSON BEAM - 7 FOOT	800301
m. CLAMP EXTENSION - 10 FOOT	800423
n. 90 deg. CLAMP ADAPTER	800049

2. The spare parts list SECTION VIII - RECOMMENDED SPARE PARTS contains spare parts which may be very useful in keeping down-time to a minimum, especially in remote or secluded job sites where unforeseen communication problems could cause delay of the delivery of an awaited part.

These RECOMMENDED SPARE PARTS may be ordered beforehand, individually or as a package group as shown in the PARTS LIST.

VIII. ORDERING PARTS

VIBRATION SUPPRESSOR

800027

## VIBRATION SUPPRESSOR

800027

Item	Part Number	Qty.	Description
1	810037	1	416L Trans. Case Asm.
2	100816	1	416L Suppressor Housing
3	100809	2	Retainer
4	100808	1	Stop Pin
5	100806	1	Spacer
6	400037	2	.75 - 10 UNC X 1.25 LG SHCS
7	100818	1	416L Trans. Adapter
8	100804	1	Hose Chute
9	100802	2	1.25 - 12 UNF x 2.50 LG HHCS
10	120301	2	1.25 - 12 UNF Lock Nut
11	400785	2	1 - 8 UNC X 1.75 LG SHCS
12	400787	2	1" High Collar Lock Washer
13	100392	1	Hose Clamp
14	100011	4	.5 - 13 UNC x 2.00 LG SHCS
16	130135	3	.625 - 10 UNC x 3.50 LG SHCS
17	400069	64	.75 - 10 UNC x 2.00 LG SHCS
18	100069	18	.75 Lock Washer
19	100782	96	.75 - 10 UNC Flange Nut
20	100067	48	.75 - 10 UNC x 2.50 LG SHCS
21	100071	28	.625 - 11 UNC x 2.50 LG SHCS
22	100007	31	.625 Lock Washer
23	100796	16	Elastomer
24	100063	2	FITT2P-16P000000-000S007
25	100800	1	Check Valve (CV-6)
26	100798	2	FITT2T-16M16M16P-0000001
27	100794	3	1-1/2 U-bolts
28	100790	2	HOSE100PT4J016J016L03700
29	100780	2	FITT2T-16M16M16J-000J001
30	110209	2	FITT2L-20P16M000-0000001
31	100432	2	HOSE075PT4H912J016L06400
32	100430	2	HOSE075PT4H912J016L06200
33	100788	1	HOSE050R01J908J008L06200
34	100792	1	HOSE050R01J908J008L10100
35	100032	1	Relief Valve (RV-3)
36	110838	1	FITT2T-08Q08Q08Q-0000001
37	300377	1	FITT2T-08M08M08P-0000001
38	400395	1	FITT2S-12N08P000-000H001
40	120525	2	FITT2L-06P06N000-000H001
41	120593	2	FITT2T-06M06M06P-000H001
42	100057	2	FITT2C-06J000000-000H001



## VIBRATION SUPPRESSOR (Continued)

800027

<u>Item</u>	<u>Part Number</u>	<u>Qty.</u>	<u>Description</u>
46	400159	1	FITT2S-24P20Q000-000H001
47	110139	1	FITT2S-24Q24N000-000H001
48	100235	1	FITT2S-20Q20N000-000H001
50	100622	2	Hose Clamp Insert
51	100620	2	Band Clamp
52	100097	4	2-214 O-RING 70 DURO
53	100378	1	Hold Down Bar

VIBRATION CASE

8100037

## VIBRATION CASE

810037

Item	Part Number	Qty.	Description
1	810051	1	416L Transmission Case
2	100754	8	Bearing Covers
3	100119	68	.5 - 13 UNC x 1.25 LG SHCS
4	100752	4	Eccentric Shaft
5	100678	8	Snap Ring
6	100824	8	Bearing
7	810417	2	Eccentric Gear Asm.
8	810437	2	Eccentric Gear Asm.
9	100739	2	Motor Gear
10	100755	2	Motor Shaft
11	100750	2	Bearing Housing
12	100445	8	.5 - 13 UNC x 1.00 LG SHCS
13	100822	2	Breather
14	100161	4	Motor Bearings
15	100434	2	Drive Motor 416L (V)
16	100163	8	.50 - 13 UNC x 1.75 LG SHCS
17	100027	8	.50 Hi Collar Lock Washer
18	100185	1	Sight Gage
19	140467	8	12PH Split Flange Half
20	130117	16	.375 x 1.50 LG SHCS
21	400149	16	.375 Lock Washer
22	100139	2	FITT2S-08M08R000-000H001
23	100742	1	RH Motor Guard
24	100744	1	LH Motor Guard
25	100121	20	.5 Lock Washer
26	100735	3	Transmission Oil / Gal
27	100187	2	FITT2P-12P000000-000S0M7
28	110197	2	#159 O-Ring
29	100814	1	Sealant
30	100662	2	Filter
31	100483	12	.50 Flat Washer

HOSE ASSEMBLIES - INTERCONNECTING

800029

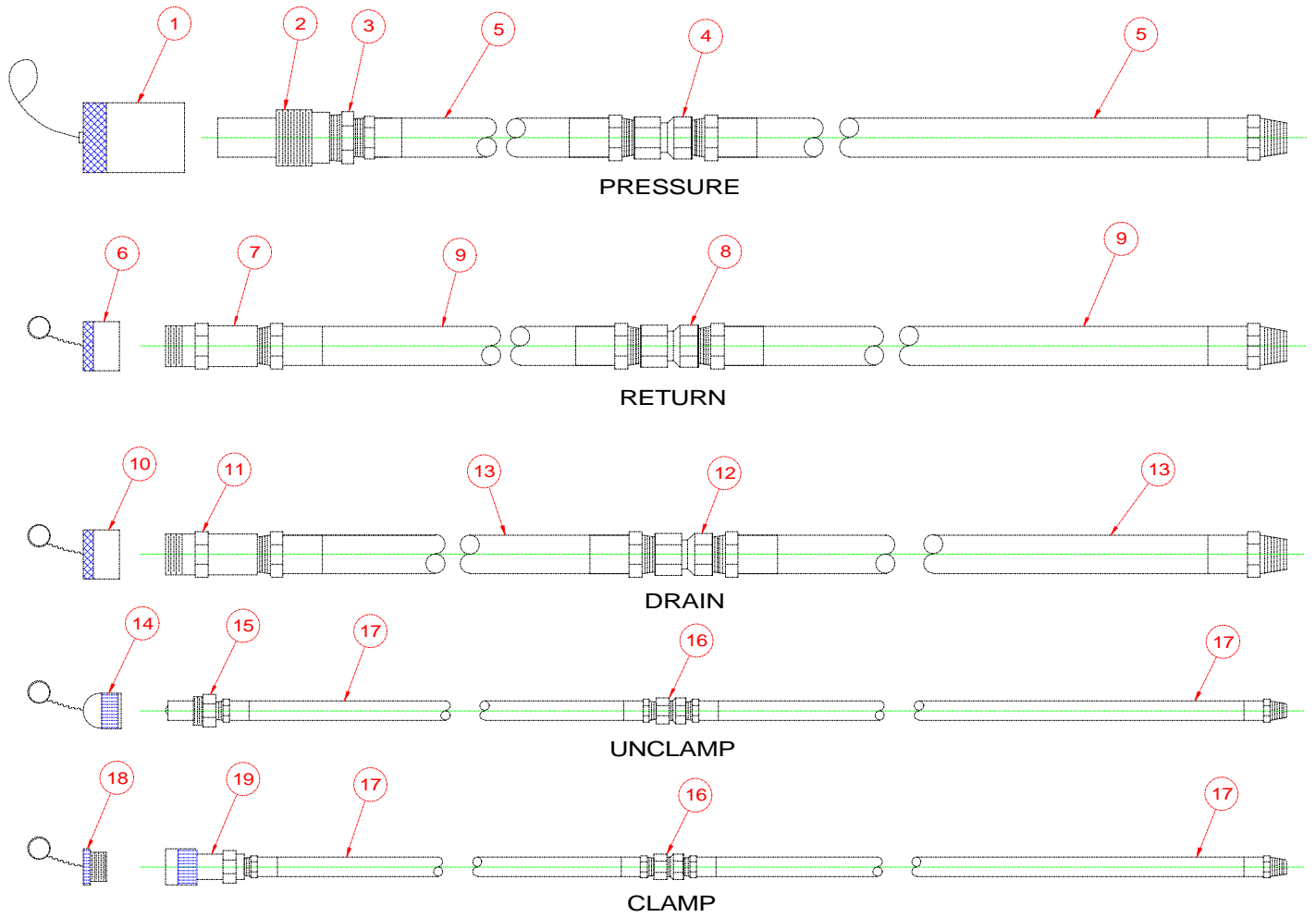



## HOSE ASSEMBLIES - INTERCONNECTING

800029

Part			
Item	Number	Qty.	Description
1	110955	1	Dust Cap (1 - 1/2)
2	110690	1	Male Disconnect (1 - 1/2)
3	400159	1	FITT2S-24P20Q000-000H001
4	100235	1	FITT2S-20Q20N000-000H001
5	100233	2	HOSE125R10P020P020L60000
6	110957	1	Dust Plug (1 - 1/2)
7	110692	1	Female Disconnect (1 - 1/2)
8	110139	1	FITT2S-24Q24N000-000H001
9	100911	2	HOSE150R02P024P024L60000
10	400253	1	Dust Cap (3/4)
11	400251	1	Male Disconnect (3/4)
12	100243	1	FITT2S-12Q12N000-000H001
13	100241	2	HOSE075R02P012P012L62000
14	100257	1	Dust Cap (3/8)
15	100245	1	Male Disconnect (3/8)
16	100249	2	FITT2S-06Q06N000-000H001
17	100247	4	HOSE038R02P006P006L62000
18	100737	1	Dust Plug (3/8)
19	100777	1	Female Disconnect (3/8)
20	130243	10	Rubber Tie Down

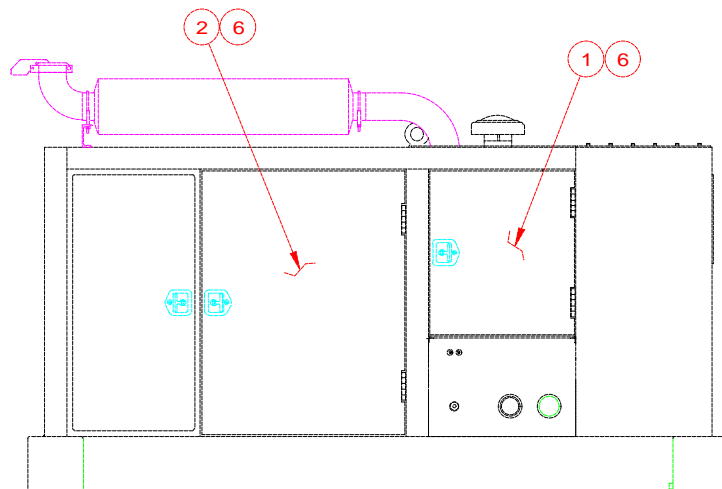
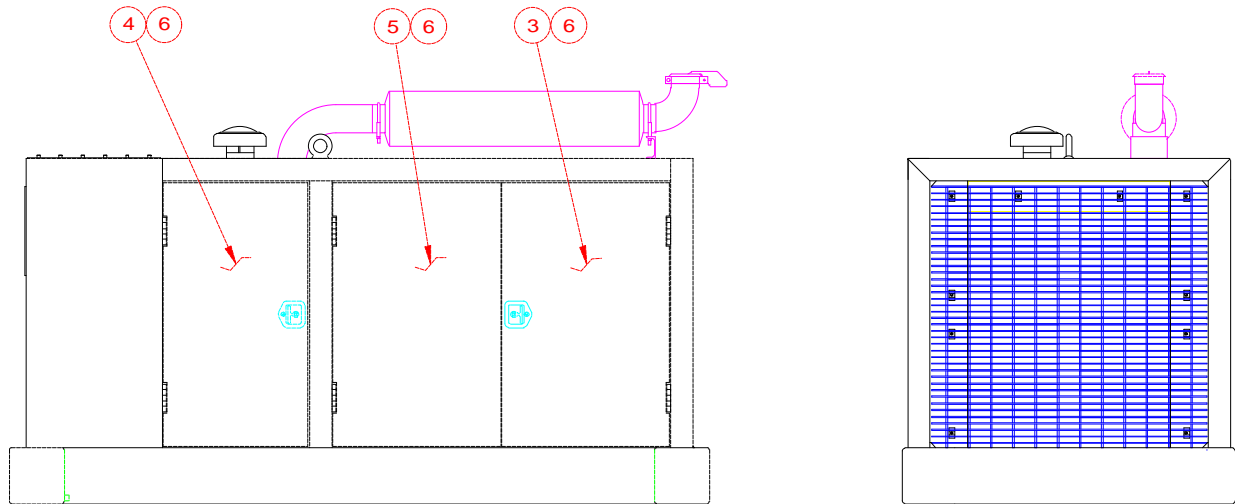

## POWER UNIT ENCLOSURE - 325

800379

<u>Item</u>	<u>Part Number</u>	<u>Qty.</u>	<u>Description</u>
1	100550	1	Cover Door
2	100548	1	Cover Door
3	100546	1	Cover Door
4	100544	1	Cover Door
5	100542	1	Cover Door
6	100834	10	5" Door Hinge

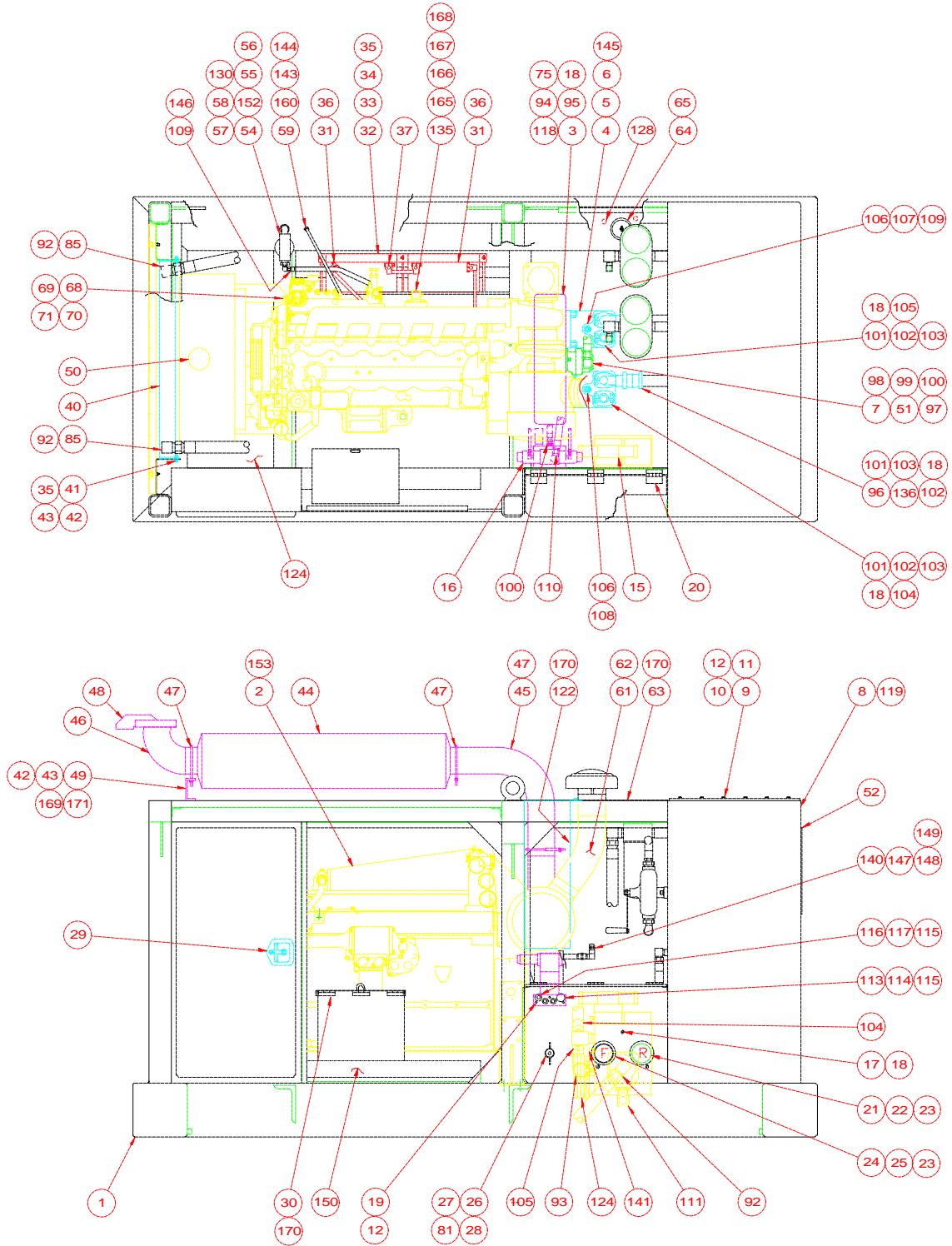

For view of power unit front elevation, return filter and electric throttle details see page VIII-18

## 325 POWER UNIT - INTERNAL

800377

Item	Part Number	Qty.	Description
1	810563	1	300 P.U. FUEL BASE ASM
2	100508	1	3306TA DIESEL ENGINE
3	100512	1	MULTI-PUMP ADAPTER
4	100406	2	MAIN PUMP(F12-110)
5	100587	8	.75-10 HEX NUT
6	100589	8	.75 FLATWASHER
7	100684	1	CLAMP PUMP
8	100552	1	RESERVOIR (300)
9	400129	1	RESERVOIR COVER
10	400225	1	RESERVOIR GASKET
11	100648	26	.375-16 X.875 LG SHCS
12	400149	31	.375 LOCKWASHER
13	100520	2	RETURN FILTER ASM.
14	100518	4	RETURN FILTER ELEMENT
15	810571	1	300 DRIVE MANIFOLD ASM.
16	810449	1	570C CLAMP MANIFOLD ASSM.
17	100119	3	.5-13 X 1.25 LG SHCS LOCWEL
18	100121	27	.5 LOCKWASHER MEDIUM
19	100051	6	.375-16 X 1.0 LG SHCS LOCWEL
20	100534	1	COUPLER PANEL (300)
21	110690	1	1.5 MALE DISCONNECT
22	110955	1	1.5 DUST CAP
23	110392	2	FITT2S-24R24P000-000H001
24	110692	1	1.5 FEMALE DISCONNECT
25	110957	1	1.5 DUST PLUG
26	400095	1	.75 FEMALE DISCONNECT
27	400121	1	.75 DUST PLUG
28	100387	1	FITT2S-12P12B000-000H001
29	810585	1	300 CONTROL BOX ASM.
30	100558	1	TOOL BOX
31	400890	2	BATTERY
32	400888	1	BATTERY HOLDDOWN
33	400231	3	HOLD DOWN STUD
34	100831	3	.312 WING NUT
35	100293	19	.312 FLATWASHER
36	100537	2	BATTERY CABLE-24"
37	110653	1	BATTERY CABLE-6
38	100873	1	RIGHT HEAT EXCHANGE BKT
39	100871	1	LEFT HEAT EXCHANGE BKT
40	400099	1	HEAT EXCHANGER
41	100105	1	312-18 X 1.0 LG SHCS LOCWEL
42	100287	12	.312 LOCKWASHER
43	100289	10	.312-18 HEX NUT

325 POWER UNIT - INTERNAL

800377

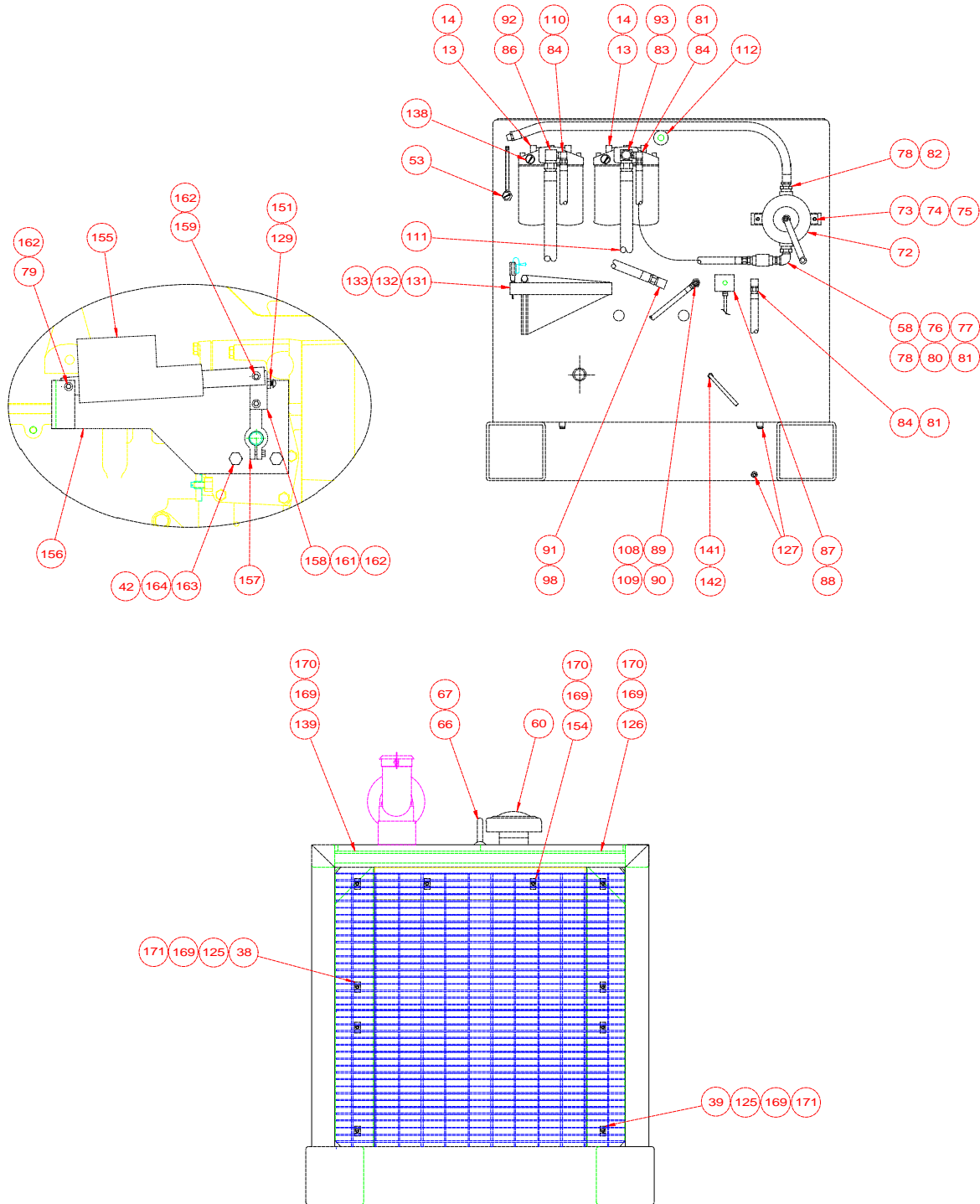

For side elevation and top view of Power Unit, see page VIII-16

## 325 POWER UNIT - INTERNAL

800377

Item	Part Number	Qty.	Description
44	400898	1	MUFFLER
45	100516	1	EXHAUST ELBOW (5"-LG)
46	400894	1	EXHAUST OUTLET ELBOW
47	140369	3	5 IN. U-CLAMP
48	140411	1	5.0 RAIN CAP
49	100532	1	MUFFLER SUPPORT
50	100726	7	ANTIFREEZE/GAL
51	100700	2	.375-16 UNC X 1.25 HHCS
52	400277	1	I C E LOGO PLATE
53	130179	1	SIGHT GAUGE AND THERM.
54	120611	1	WATER SEPERATOR ASM.
55	120425	1	FITT2S-16P16P000-1200301
56	110706	1	FITT2S-16P08Q000-000H001
57	110173	1	FITT2S-08M08P000-000H001
58	110377	2	FITT2L-16P16Q000-0000306
59	110633	1	HOSE038R02J006J006L0370S
60	100514	1	AIR INTAKE BONNET
61	100951	20	FLEXHAUST/IN
62	130237	2	HOSE CLAMP
63	100540	1	UNIT COVER(300)
64	100417	1	FITT2C-48Q000000-0000306
65	100419	1	PETCOC
66	100460	11	.25-7 X12 LG EYE BOLT
67	100722	1	ROLL PIN .25 X 3.5
68	100071	4	.625-11 X 2.5 LG SHCS LOCWEL
69	130141	4	.625 FLAT WASHER
70	100007	4	.625 LOCKWASHER-MEDIUM
71	100273	4	.625-11 HEX NUT
72	100447	1	HAND PUMP
73	100439	2	.437-X1.75 LG SHCS
74	400153	2	.437 FLATWASHER
75	100443	14	.437 LOCKWASHE
76	100449	1	FITT2S-16P16P000-000H001
77	100451	1	CHECK VALVE
78	110089	2	FITT2S-20P16Q000-000H001
79	110163	1	.25-20 X 3.5 LG SHCS
80	300119	1	FITT2S-16P12M000-000H001
81	130201	2	HOSE075R01J012J012L04000
82	400215	1	HOSE100R01P016P016L08400
83	810573	1	SPECIAL TEE
84	100489	3	FITT2L-12M12P000-0000001
85	100588	2	FITT2L-24M24P000-0000001
86	810575	1	SPECIAL 90 ELBOW

Item	Part Number	Qty.	Description
87	400115	1	TEMPERATURE SWITCH
88	110237	1	STR S/O CORD ADAPTER
89	400409	1	FITT2S-12P08Q000-000H001
90	300401	1	FITT2T-08M08P08M-0000001
91	120055	1	FITT2L-16M16P000-0000001
92	100500	2	HOSE150R01J024J024L11800
93	100498	1	HOSE150R02J924J024L07200
94	100462	12	.437-14 UNC X 1.25 LG HHCS
95	100445	8	.5-13 X 1.0 LG SHCS LOC WELL
96	100454	2	2" TUBE FLEX MASTER
97	100938	1	FITT2L-16M12R000-000H001
98	100862	1	HOSE100R01J016J016L03300
99	300099	1	FITT2S-10R08M000-000H001
100	110461	1	HOSE050R09J008J008L04000
101	110986	8	#20 SPLIT FLANGE HALF
102	100037	4	2-222 O-RING 70 DURO
103	400739	16	.5-13 UNC X 2 LG HHCS
104	100492	1	HOSE100PT4J020H020L04000
105	100490	1	HOSE100PT4J020H920L06500
106	110325	2	FITT2S-12R08M000-000H001
107	100488	1	FITT2V-08M08J000-000H001
108	100486	1	HOSE050R01J008J008L01450
109	110265	2	HOSE050R01J008J008L02300
110	100484	1	HOSE075R01J012J012L08400
111	100482	1	HOSE150R02J024J024L07200
112	100455	1	BREATHER
113	100777		1.375 FEMALE DISCONNECT
114	100737	1	.375 DUST PLUG
115	110794	2	FITT2S-06P06P000-000H001
116	100245	1	.375 MALE DISCONNECT
117	100257	1	.375 DUST CAP
118	100735	2	TRANSMISSION OIL/GAL
119	140415	275	HYDRAULIC FLUID/GAL
120	100299	3	PRIMER/GAL
121	100298	3	ICE GREEN PAINT/GAL
122	100536	1	EXHAUST SHIELD
125	100404	21	NTAKE GRILL (300)
126	100400	1	LEFT EXHAUST GRILL
127	100423	4	FITT2P-08P000000-000S007
128	120523	2	FUEL BASE MAGNET
129	110827	110	-32 X .75 BHCS S.S.
130	110819	1	SUCTION FILTER TUBE
131	810045	1	HEX KEY GROUP



## 325 POWER UNIT - INTERNAL

800377

Item	Part Number	Qty.	Description
132	100651	1	24 V TEST LIGHT
133	100600	1	HEX KEY RACK
134	100502	1	THROTTLE BRKT
135	100504	1	24V SOLENOID
136	100458	2	90 DEG. FLANGED ADAPTER
138	100436	2	GAGE (0-60 PSI.)
139	100402	1	RIGHT EXHAUST GRILL
140	100476	1	FITT2S-08P08P000-0300301
141	100478	1	HOSE038R01J006J006L0200
142	130399	1	FITT2S-06M04P000-000H001
143	400411	1	FITT2L-06M06J000-000H001
144	100936	1	FITT2S-06M04R000-000H001
145	100069	8	.75 LOCKWASHER MEDIUM
146	100787	1	FITT2L-08M08R000-000H001
147	300443	1	FITT2S-08Q08Q000-000H001
148	300067	1	FITT2L-08P08Q00-000H001
149	100474	1	BREATHER
150	100524	1	TUBE-4X4X11GAX33
151	400163	1	#10-32 HEX NUT
152	120613	1	WATER SEPERATOR ELEMENT
153	400247	28	ENGINE OIL/QUART
154	100394	1	TOP AIR BAFFLE
155	110460	1	ELECTRIC ACTUATOR(24V)
156	100426	1	ELECTRIC THROTTLE BRACKET
157	110458	1	THROTTLE ARM
158	100424	1	THROTTLE LINK
159	100631	1	.25-20 X 2.0 LG SHCS
160	400203	1	FITT2S-06M06P000-000H001
161	100595	1	.25-20 X 1.25 LG SHCS
162	100422	3	.25-20 UNC ESNA NUT
163	150179	2	.312-18 X .75 HHCS
164	100293	2	.312 FLATWASHER
165	100428	1	SOLENOID BRACKET
166	130061	2	#10-32 x .5 BHCS STN STL
167	300671	2	#10 FLAT WASHER
168	400161	2	#10 LOCKWASHER
169	100398	20	SADDLE CLIP
170	110830	10	.25 X 2 IN. HEX TEX SCREW
171	100396	8	.312-18UNC x 1.50 LG. SHCS

CONTROL BOX

810585

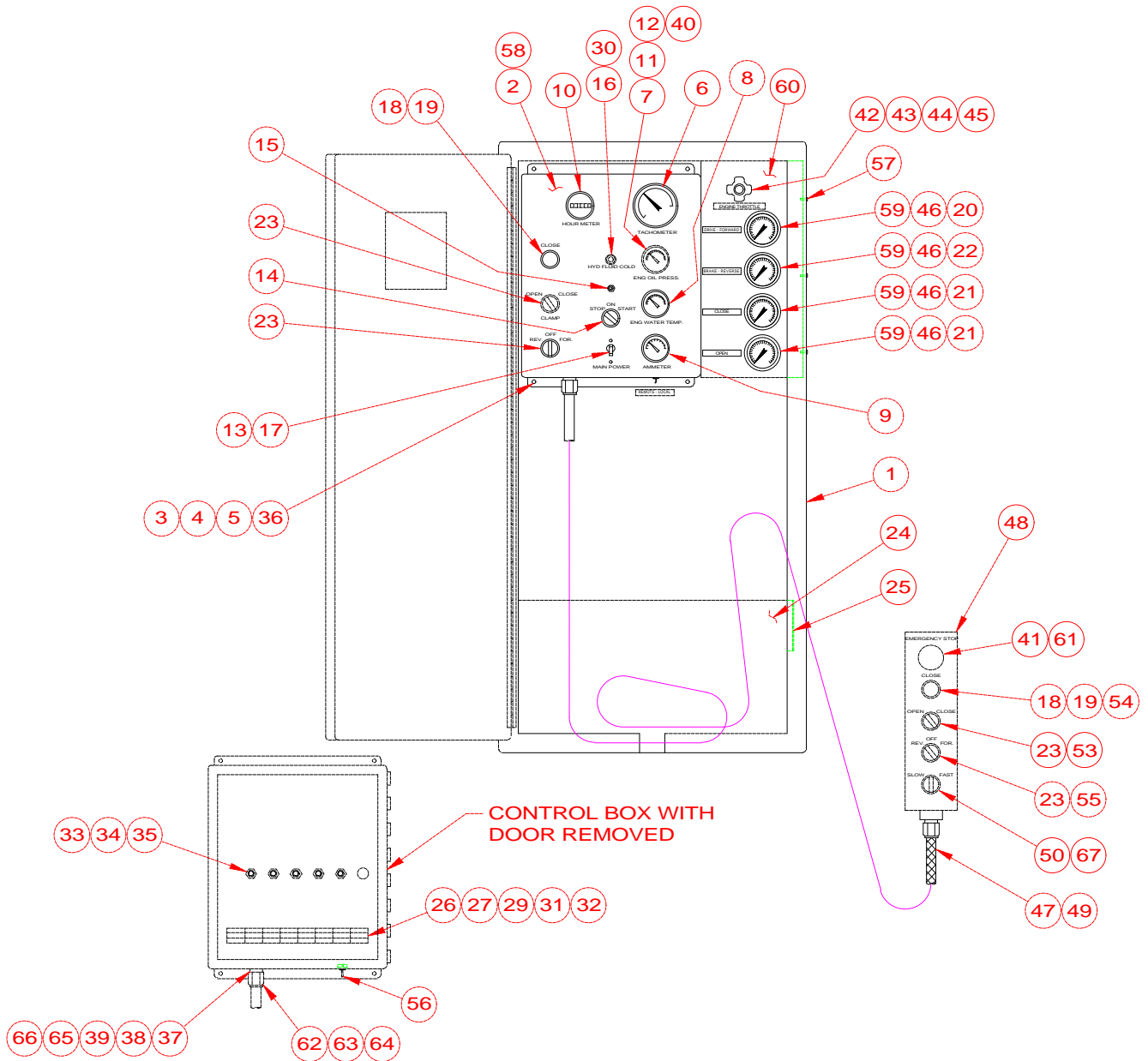

## CONTROL BOX

810585

Item	Part Number	Qty.	Description
1	130151	1	Control Box Enclosure
2	100740	1	Control Box
3	100576	4	.25 - 20 UNC x .625 LG SHCS
4	100559	4	.25 Lock Washer
5	100598	4	.25 - 20 UNC Hex Nut
6	130465	1	Tachometer
7	100329	1	Oil Pressure Gage
8	130251	1	Water Temp. Gage
9	110371	1	Ammeter
10	100343	1	Hour Meter
11	110415	5	Oil Press. Hose
12	100333	1	FITT2L-04E02Q000-000H002
13	400141	1	Circuit Breaker
14	130259	1	Start Switch
15	130257	1	Reset Button
16	100355	1	Light
17	100331	2	#6 - 32 UNC x .25 LG BHCS
18	100359	2	Light
19	100361	2	Lens
20	110680	1	HOSE019R01J004J004L40000
21	130207	2	HOSE019R01J004J004L10000
22	130205	1	HOSE025R01J004J004L09000
23	130155	4	Clamp Switch
24	130149	1	Box Panel
25	130387	1	Hose Bracket
26	400161	2	#10 Lock Washer
27	400163	2	#10 - 32 UNF Hex Nut
28	130307	3	Light Bulb
29	110649	2	#10 - 32 UNF x .375 LG PHMS
30	130305	1	Light Bulb
31	110567	15	Terminal Block
32	110569	10	Terminal Mounting Channel
33	100853	5	90° S/O Cord Adapter
34	110841	5	.5 Bushing
35	110843	5	.5 Lock Nut
36	100597	4	.25 Flat Washer
37	110763	1	Female Amphenol Insert
38	100397	1	Female Amphenol Plug
39	110754	4	6 - 32 UNF x .375 LG RHMS
40	110871	1	FITT2V-04P04E000-000H002



## CONTROL BOX

810585

Item	Part Number	Qty.	Description
41	130509	1	Emergency Stop Label
42	130255	1	Engine Throttle
43	100429	1	Throttle Cable Seal
44	110964	1	Throttle Cable Pivot
45	100577	1	Throttle Cable Clamp
46	100321	4	FITT2L-04M04Q000-000H001
47	100560	50	Pendant Cable
48	130505	1	Pendant Enclose
49	110603	1	Strain Relief
50	100562	1	Slow-Fast Name Plate
51	100359	1	Light
52	100361	1	Lens
53	100401	1	Open/Close Name Plate
54	100403	1	Close Name Plate
55	100864	1	Rev - For Name Plate
56	140361	1	Toggle Switch
57	100656	6	#10 - 32 x .5 LG Sheet Mtl Scr
58	100468	1	325 Label Group
59	110600	4	0-6000 PSI Gage (GA1-4)
60	100738	1	Gage Panel
61	130507	1	Emergency Stop Button
62	100375	1	Strain Relief
63	110761	1	Male Amphenol Insert
64	100395	1	Male Amphenol Plug
65	110696	4	#6 Lockwasher
66	110694	4	#6-32 UNF Hex Nut
67	100566	1	Switch

# CONTROL MANIFOLD ASSEMBLY

810571

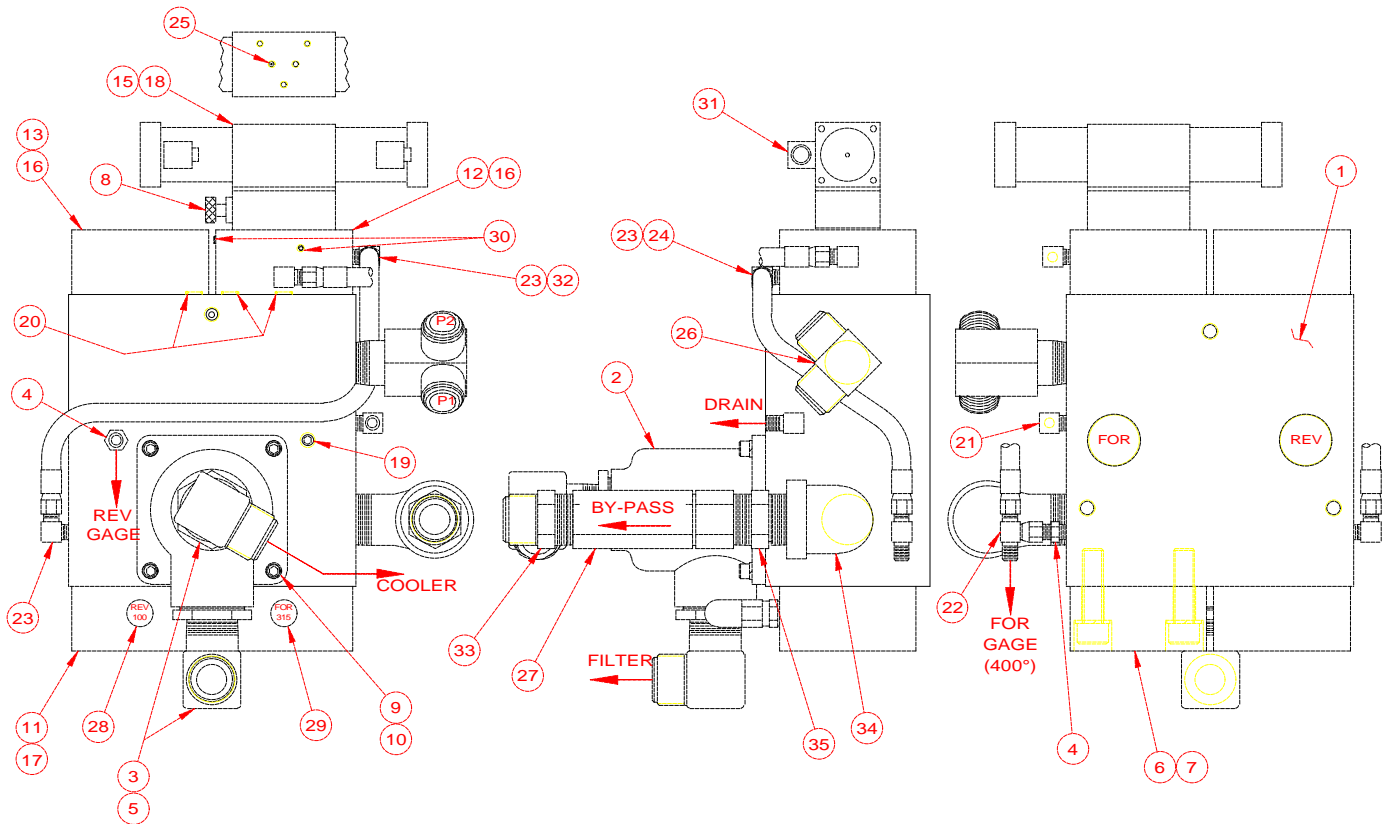

## CONTROL MANIFOLD ASSEMBLY

810571

Item	Part Number	Qty.	Description
1	100758	1	Manifold Block
2	110628	1	Cooler Valve (V-3)
3	100588	2	FITT2L-24M24P000-0000001
4	110203	2	FITT2S-04M04P000-000H001
5	100547	2	FITT2S-32P24Q000-000H306
6	400039	16	.75-10 UNC x 2.75 LG SHCS
7	100069	16	.75 Lockwasher
8	100654	1	Sandwich Shut-Off Valve (V-4)
9	100143	4	.375-16 UNC x 1.25 LG SHCS
10	400149	4	.375 Lockwasher
11	110544	1	Cartridge Cover (CC4)
12	110530	1	Cartridge Cover (CC1)
13	110606	1	Cartridge Cover (CC2)
14	110546	1	Cartridge Cover (CC3)
15	100650	4	.25-20 UNC x 4.5 LG SHCS
16	110624	2	Cartridge A
17	110622	2	Cartridge B
18	810519	1	Modified Spool Valve (V2)
19	100845	2	FITT2P-04P000000-000S007
20	110602	3	111-O-Ring
21	140581	1	FITT2L-06M04P000-0000001
22	100556	1	F1TT2T-04M04M04J-0000001
23	100145	3	FITT2L-04M04P000-0000001
24	100149	1	HOSE025R02J004J004L01900
25	140387	1	Orifice - .059 Dia.
26	100608	1	Special Tee
27	130339	1	1.5 Check Valve (CV-2)
28	100630	1	Rev. Cartridge (100) (RV4)
29	100632	1	For. Cartridge (315) (RV1)
30	100646	2	FITT2P-02P000000-000S007
31	100990	2	Electric Connector
32	100719	1	HOSE025R02J004J004L03000
33	100565	1	FITT2S-24M24P000-000H001
34	100446	1	FITT2L-24P24Q000-0000001
35	110037	1	FITT2S-24P24P000-000H001

CLAMP MANIFOLD

810449

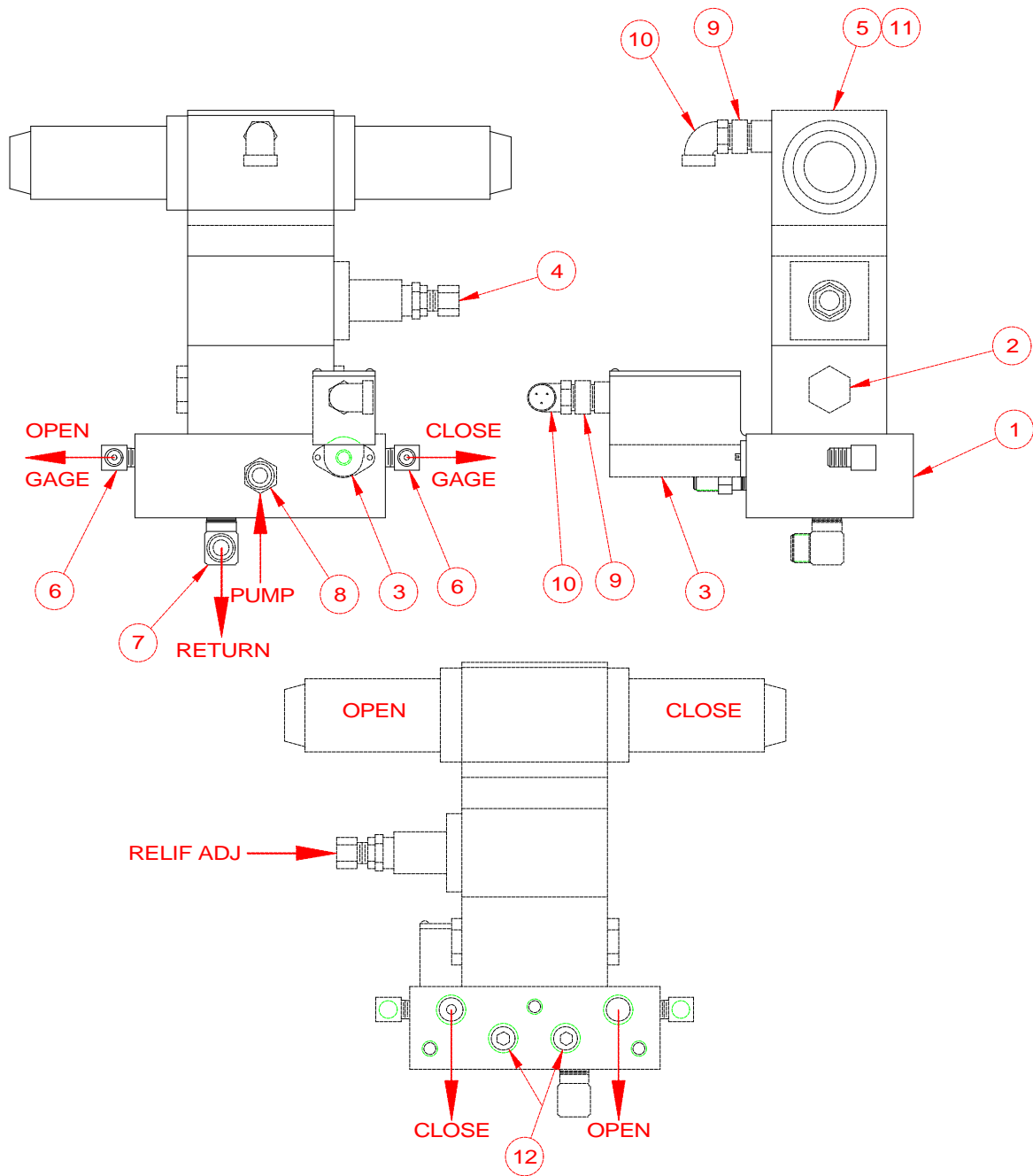



## CLAMP MANIFOLD

810449

<u>Item</u>	<u>Part Number</u>	<u>Qty.</u>	<u>Description</u>
1	110642	1	Manifold Block
2	110149	1	Check Valve (CV-5)
3	810033	1	Pressure Switch (PS-1)
4	100898	1	Relief Valve (RV2)
5	110147	1	4-way Solenoid Valve (V-1)
6	140539	2	FITT2L-04M02P000-0000001
7	110632	1	FITT2L-12M06P000-000H001
8	110630	1	FITT2S-08M06P000-000H001
9	110885	1	Conduit Adapter
10	110235	1	90° S/O Cord Adapter
11	110634	4	.25 - 20 UNC x 7.50 LG SHCS
12	400213	2	FITT2P-06P000000-000S007

126B CLAMP ASSEMBLY (OPTIONAL)

800327

## 126B CLAMP ASSEMBLY (OPTIONAL)

800327

Item	Part Number	Qty.	Description
1	810493	1	126B Clamp Body Asm.
2	810491	1	Cylinder
3	100212	12	1-8 UNC x 4.0 LG. SHCS
4	100209	19	1" Lockwasher
5	120567	1	Rod End Cap
6	120569	1	Piston
7	100213	7	1-8 UNC x 2.50 LG. SHCS
8	120575	1	Cylinder Rod
9	120347	1	261-O- Ring (Note)
10	120285	2	Piston Bearing (Note)
11	120283	2	Piston Seal (Note)
12	120555	1	Rod Bearing (Note)
13	120553	1	Rod Seal (Note)
14	100983	1	Pile Guide
15	120401	1	2-269 O-RING 90 DURO (Note)
16	130057	2	FITT2L-06M06R000-000H001
17	100229	1	Grease Fitting
18	100193	8	1.5-6 UNC x 5.0 LG. SHCS
19	100195	8	1.5 Lockwasher
20	100791	1	Clamp Label
21	130381	4	Rivet
22	120009	2	HOSE038R02J006J006L0960S
25	100230	2	FITT2P-06M000000-000T001
26	810515	1	126B Seal Kit
27	810495	1	Universal Movable Jaw
28	110515	1	Universal Fixed Jaw
29	810497	1	H-Beam Movable Jaw
30	110541	1	H-Beam Fixed Jaw
31	810499	1	DS-Movable Jaw
32	110419	1	DS-Fixed Jaw
33	130449	1	Spiral Roll Pin
34	120629	1	Holding Valve

Note; Included in 126B Seal Kit.

MODEL 127 Z-PILE CLAMP (OPTIONAL)

800041

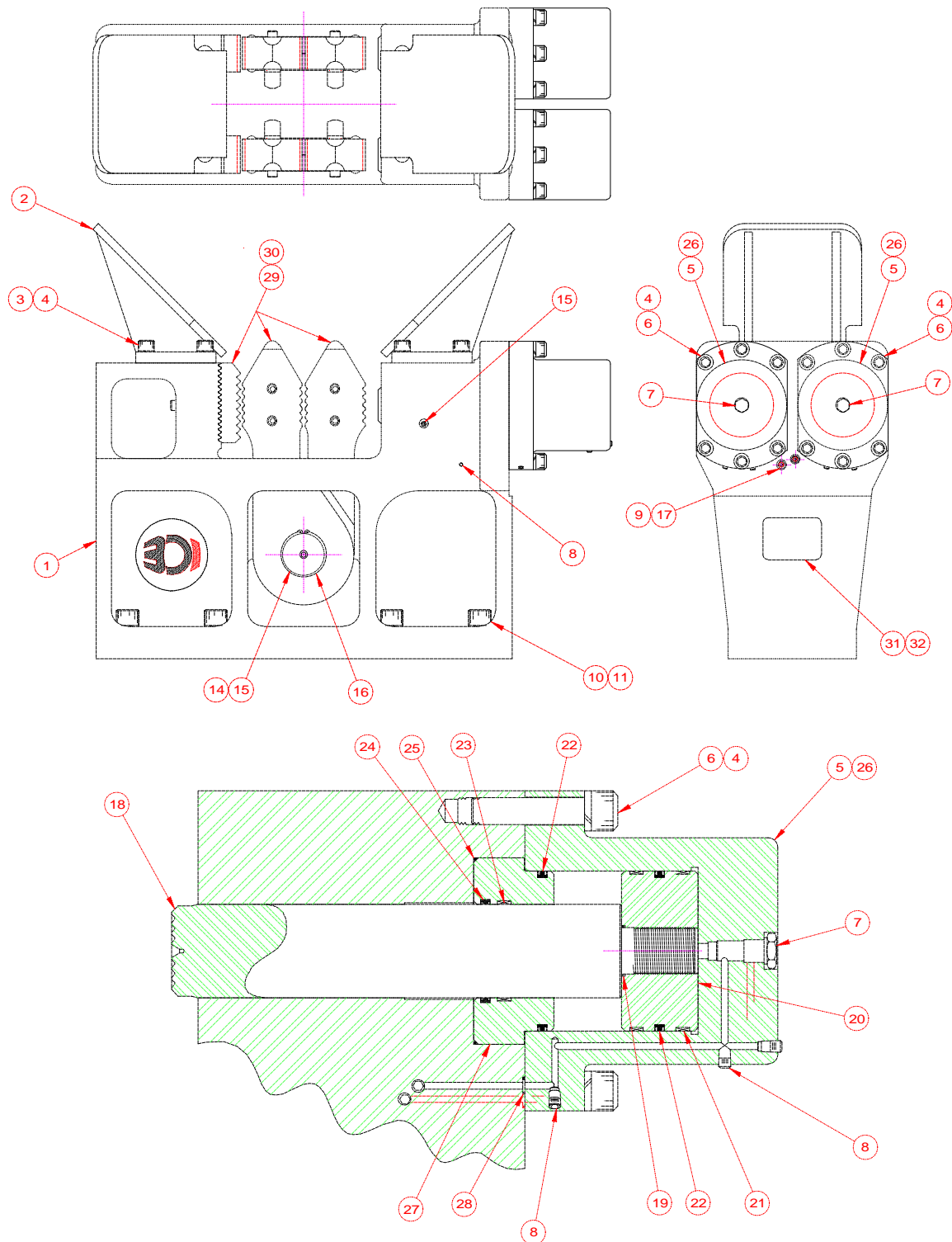

CYLINDER ASSEMBLY DETAIL

## MODEL 127 Z-PILE CLAMP (OPTIONAL)

800041

Item	Part Number	Qty.	Description
1	810059	1	127 Z CLAMP BODY CASTING
2	120677	2	PILE GUIDE
3	100213	8	1.0-8 X 2.5 LG SHCS LOCWEL
4	100209	20	1.0 LOCKWASHER MEDIUM
5	120659	2	127B CYLINDER
6	100212	12	1.0-8 X 4 LG SHCS LOCWEL
7	120629	2	HOLDING VALVE CARTRIDGE
8	100646	10	FITT2P-02P000000-000S007
9	100053	2	FITT2S-06MO6R000-000H001
10	100193	8	1.5-6 X 5.0 LG SHCS
11	100195	8	1.5 LOCKWASHER EXTRA HEAVY
14	120155	1	SHAFT
15	100229	4	GREASE FITTING
16	120191	2	RETAINER RING
17	120009	2	HOSE038R02J006J006L0960S
18	120663	2	CYLINDER ROD(127B)
19	120239	2	2-132 O-RING
20	120241	2	PISTON-127
21	120243	4	PISTON BEARING
22	120245	4	PISTON SEAL
23	120665	2	ROD BEARING (127B)
24	120667	2	ROD SEAL (127B)
25	120347	2	2-261 O-RING 90 DURO
26	810629	2	127B Z SEAL KIT
27	120661	2	ROD END CAP(127B)
28	110602	4	111 O-RING
29	800419	1	12" MULTI-GRIP JAW SET (Note)
30	800417	1	13" MULTI-GRIP JAW SET (Note)
31	120181	1	127 S/N PLATE
32	130381	4	RIVET

Note : Not part of Final Assembly.

MODEL 80B CAISSON CLAMP (OPTIONAL)

800047

## MODEL 80B CAISSON CLAMP (OPTIONAL)

800047

Item	Part Number	Qty.	Description
1	810061	1	Clamp Body
2	120101	2	Wedge
3	120103	2	Lock
4	810109	2	Screw Asm.
5	120107	1	Fixed Jaw
6	400157	2	.625-11UNC x 2.75 Lg. SHCS
7	120111	4	Washer
8	120113	8	Drive Pin
9	120115	4	Spring
10	100229	3	Grease Fitting
11	120119	1	Wedge Guard
12	100119	2	.5-13UNC x 1.25 Lg. SHCS
13	100121	2	.5 Lockwasher
14	120159	1	Clamp Label
15	130381	4	Rivet
16	130057	2	FITT2L-06M06R000-000H001
17	100646	7	FITT2P-02P000000-000S007
20	120621	1	Cylinder
21	100212	8	1.00-8UNC x 4.00 Lg. SHCS
22	100209	8	1.00 Lockwasher
23	120631	1	Cylinder Rod
24	120623	1	Rod End Cap
25	120100	1	263-O-Ring (Note)
26	120627	1	Rod Bearing (Note)
27	120625	1	Rod Seal (Note)
28	120345	1	Rod Wiper (Note)
29	120347	1	#261-O-Ring (Note)
30	120349	1	#261-Back-up Ring (Note)
31	120313	1	Piston
32	120281	1	#140-O-Ring (Note)
33	120357	1	Piston Seal (Note)
34	120355	2	Piston Bearing (Note)
35	120629	1	Holding Valve
36	810611	1	80B Seal Kit

Note: Included in Model 80B Seal Kit.

7 FOOT CAISSON BEAM (OPTIONAL)

800301



## 7 FOOT CAISSON BEAM (OPTIONAL)

800301

Item	Part Number	Qty.	Description
1	120001	1	7' Caisson Beam
2	120011	2	Clamp Stop
3	400069	4	.75 - 10 UNC x 2" LG SHCS
4	100069	4	.75 Lockwasher
5	120007	15	1.50 - 6 UNC x 8" LG SHCS
6	810173	1	Adjustment Tool
*7	800047	2	Model 80 Caisson Clamp
8	100111	2	HOSE038R02J006J006L0875S
9	120595	2	HOSE038R02J006J006L1800S
10	120593	2	FITT2T-06M06M06P-0000001
11	130219	15	1.50 Hi-Collar Lockwasher
12	100230	4	FITT2P-06M000000-000T001

\*=Not part of Caisson Beam Asm.

10 FOOT CLAMP EXTENSION (OPTIONAL)

800423

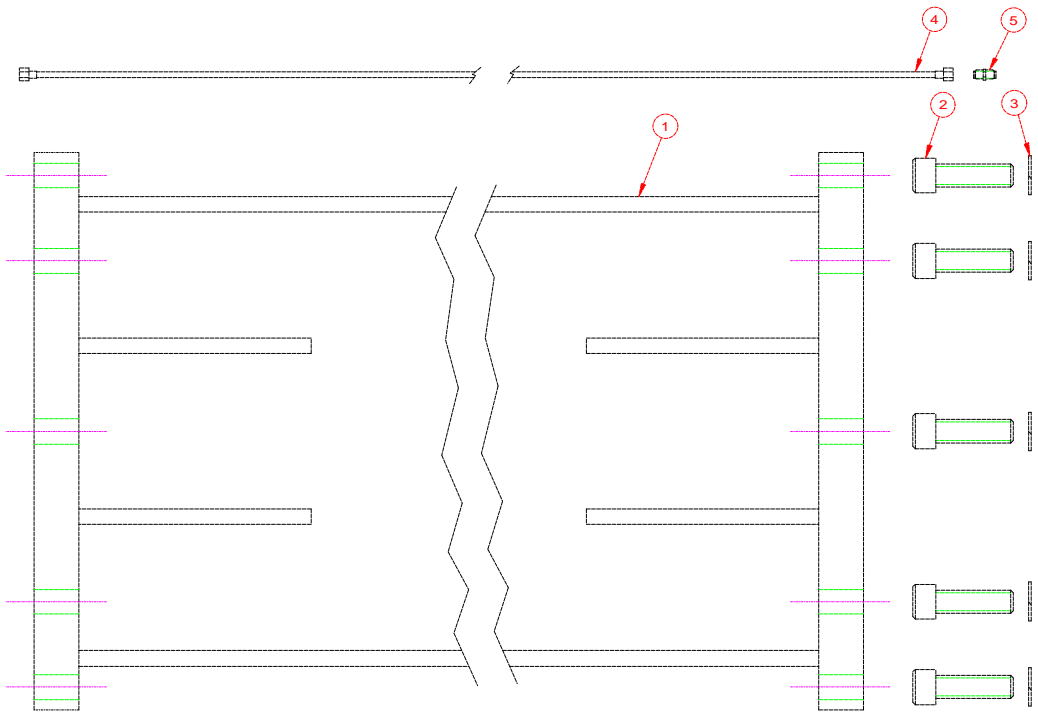

90 DEG. CLAMP ADAPTER (OPTIONAL)

800049

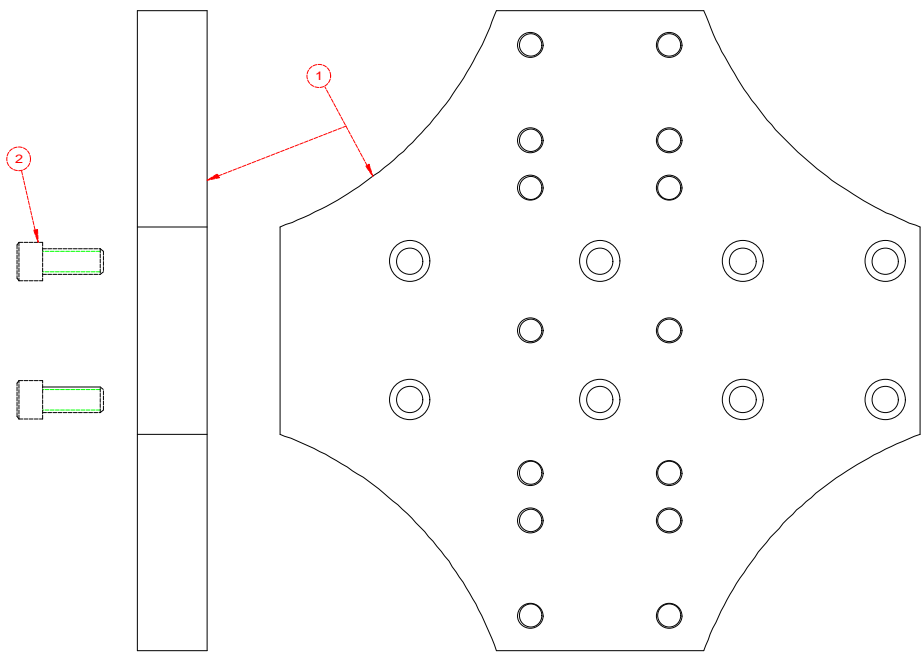

10 FOOT CLAMP EXTENSION (OPTIONAL)

800423

<u>Item</u>	<u>Part Number</u>	<u>Qty.</u>	<u>Description</u>
1	810655	1	10' Extension
2	100193	10	1.50-6 UNC x 5.00 LG. SHCS
3	100195	10	1.50 Lockwasher
4	120193	2	HOSE038R02J006J006L1320S
5	120081	2	FITT2S-06M06M000-000H001

90 Deg. CLAMP ADAPTER (OPTIONAL)

800049

<u>Item</u>	<u>Part Number</u>	<u>Qty.</u>	<u>Description</u>
1	120083	1	90 deg. Clamp Adapter
2	120077	8	1.50-6 UNC x 3.50 LG SHCS

VIII. ORDERING PARTS

E. MISCELLANEOUS ACCESSORIES

1. Tools

Part Number	Qty.	Description
100651	1	24-Volt Test Light
100653	1	Set of Allen Wrenches - Includes All Wrenches Shown Below:
100655		(1) 1/16" Allen Wrench - Long Arm
100691		(1) 5/64" Allen Wrench - Long Arm
100659		(1) 3/32" Allen Wrench - Long Arm
100661		(1) 7/64" Allen Wrench - Long Arm
100663		(1) 1/ 8" Allen Wrench - Long Arm
100665		(1) 9/64" Allen Wrench - Long Arm
100667		(1) 5/32" Allen Wrench - Long Arm
100669		(1) 3/16" Allen Wrench - Long Arm
100671		(1) 7/32" Allen Wrench - Long Arm
100673		(1) 1/ 4" Allen Wrench - Long Arm
100657		(1) 5/16" Allen Wrench - Long Arm
100675		(1) 3/ 8" Allen Wrench - Long Arm
100677		(1) 7/16" Allen Wrench - Long Arm
100679		(1) 1/ 2" Allen Wrench - Long Arm
100681		(1) 9/16" Allen Wrench - Long Arm
100683		(1) 5/ 8" Allen Wrench - Long Arm
100685		(1) 3/ 4" Allen Wrench - Long Arm
100687		(1) 7/ 8" Allen Wrench - Short Arm
100689		(1) 1" Allen Wrench - Short Arm

2. Bulk

Part Number	Qty.	Description
810013	5 GAL	Hydraulic Fluid
810011	5 GAL	Vibration Case Lubricant
100726	1 GAL	Coolant/Anti-Freeze
100298	1 GAL	I C E Green Paint
100299	1 GAL	Primer

VIII. ORDERING PARTS

E. MISCELLANEOUS ACCESSORIES (CONTINUED)

3. 416L Hose Group Kit - Internal 850085

Item	P/N	Qty.	Description	Page Ref.
28	100790	2	HOSE100PT4J016J016L03700	VIII-7
31	100786	2	HOSE100PT4J016J016L06200	VIII-7
32	100784	2	HOSE100PT4J016J016L06000	VIII-7
33	100788	1	HOSE050R01J908J008L06200	VIII-7
34	100792	1	HOSE050R01J908J008L10100	VIII-7

4. 325 Hose Group Kit - Internal 850105

Item	P/N	Qty.	Description	Page Ref.
59	110633	1	HOSE038R02J006J006L0370S	VIII-19
81	130201	2	HOSE075R01J012J012L04000	VIII-20
82	400215	1	HOSE100R01P016P016L08400	VIII-20
92	100500	2	HOSE150R01J024J024L18000	VIII-20
93	100498	1	HOSE150R02J924J024L07200	VIII-20
98	100862	1	HOSE100R01J016J016L03300	VIII-20
100	110461	1	HOSE050R09J008J008L04000	VIII-20
104	100492	1	HOSE100PT4J020H020L04000	VIII-20
105	100490	1	HOSE100PT4J020H920L06500	VIII-20
108	100486	1	HOSE050R01J008J008L01450	VIII-20
109	110265	1	HOSE050R01J008J008L02300	VIII-20
110	100484	1	HOSE075R01J012J012L08400	VIII-20
111	100482	1	HOSE150R02J024J024L07200	VIII-20

VIII. ORDERING PARTS

E. MISCELLANEOUS ACCESSORIES (CONTINUED)

5. 416I/325 O-Ring Kit 850107

<u>P/N</u>	<u>Qty.</u>	<u>Description</u>
100037	4	O-ring (#222)
110197	2	O-ring (#159)
110602	3	O-ring (#111)
100814	1	Sealant (tube)

6. Quick Disconnect Rebuild Kit 850067

<u>Qty.</u>	<u>Description</u>
1	Male Check Poppet Valve
1	Female Check Poppet Valve
2	Snap-Lock Ring
1	Snap-Ring Pliers

VIII. ORDERING PARTS

E. MISCELLANEOUS ACCESSORIES (CONTINUED)

7. Cylinder Seal Kit

MODEL 126B CLAMP CYLINDER 810515 Refer to page VIII-30

<u>Item</u>	<u>P/N</u>	<u>Qty</u>	<u>Description</u>
9	120347	1	#261-O-Ring
10	120285	2	Piston
11	120283	2	Piston Seal
12	120555	1	Rod Bearing
13	120553	1	Rod Seal
34	120401	1	#269-O-Ring

MODEL 80B CAISSON CLAMP 800047 Refer to page VIII-34

<u>Item</u>	<u>P/N</u>	<u>Qty</u>	<u>Description</u>
25	120100	1	#263-O-Ring
26	120627	1	Rod Bearing
27	120625	1	Rod Seal
28	120345	1	Rod Wiper
29	120347	2	#261-O-Ring
30	120349	2	#261-Back-Up Ring
32	120281	1	#140-O-Ring
33	120357	1	Piston Seal
34	120355	2	Piston Bearing

VIII. ORDERING PARTS

F. RECOMMENDED SPARE PARTS

VIBRATION SUPPRESSOR 800027 Refer to page VIII-6

<u>Item</u>	<u>P/N</u>	<u>Qty.</u>	<u>Description</u>
23	100796	1	Elastomer
35	100032	1	Relief Valve

VIBRATION CASE 810037 Refer to page VIII-10

<u>Item</u>	<u>P/N</u>	<u>Qty.</u>	<u>Description</u>
18	100185	1	Sight Gage
28	110197	2	Motor O-Ring (#159)
--	110607	2	Motor Shaft Seal
29	100814	1	Sealant (Tube)
30	100662	2	Filter

HOSE ASSEMBLIES-INTERCONNECTING 800029 Refer to page VIII-12

<u>Item</u>	<u>P/N</u>	<u>Qty</u>	<u>Description</u>
5	100233	2	HOSE125R10P020P020L60000
9	100911	2	HOSE150R02P024P024L60000
13	100241	2	HOSE075R02P012P012L62000
17	100247	4	HOSE038R02P006P006L62000

POWER UNIT - INTERNAL (325) 800377 Refer to page VIII-16/18

<u>Item</u>	<u>P/N</u>	<u>Qty</u>	<u>Description</u>
--	100233	1	Oil Filter
14	100518	4	Hyd.Oil Filter
--	100450	1	Fuel Filter Element
--	100448	1	Air Filter Element
100	110461	1	HOSE050R09J008J008L04000
104	100492	1	HOSE100PT4J020H020L04000
105	100490	1	HOSE100PT4J020H020L06500



VIII. ORDERING PARTS

F. RECOMMENDED SPARE PARTS (CONTINUED)

MODEL 126B CLAMP 800327 Refer to page VIII-30

<u>Item</u>	<u>P/N</u>	<u>Qty.</u>	<u>Description</u>
16	130057	2	FITT2L-06M06R000-0000001
18	100193	8	1.5-6 UNC x 5.0 LG. SHCS
19	100195	8	1.5 Lockwasher
22	100111	2	HOSE038R02J006J00620875S
26	810515	1	126B Seal Kit
27	810495	1	Universal Movable Jaw
28	110515	1	Universal Fixed Jaw
29	810497	1	H-Beam Movable Jaw
30	110541	1	H-Beam Fixed Jaw
31	810499	1	DS-Movable Jaw
32	110419	1	DS-Fixed Jaw
33	130449	1	Spiral Roll Pin

MODEL 127 Z-PILE CLAMP 800041 Refer to page VIII-32

<u>Item</u>	<u>P/N</u>	<u>Qty.</u>	<u>Description</u>
9	100053	2	FITT2S-06MO6R000-000H001
10	100193	8	1.5-6 X 5.0 LG SHCS (Head Bolts)
11	100195	8	1.5 LOCKWASHER EXTRA HEAVY
17	120009	2	HOSE038R02J006J006L00960
26	810629	2	127B Z SEAL KIT
28	110602	4	111 O-RING

VIII. ORDERING PARTS

F. RECOMMENDED SPARE PARTS (CONTINUED)

MODEL 80B CAISSON CLAMP

800047

Refer to page VIII-34

<u>Item</u>	<u>P/N</u>	<u>Qty.</u>	<u>Description</u>
4	810109	1	Screw Assembly
5	120107	1	Fixed Jaw
6	400157	2	.625-11UNC x 2.75 LG SHCS
16	130057	2	FITT2L-06M06R000-000H001
35	120629	1	Holding Valve
36	810611	1	Seal Kit

RECOMMENDED TIGHTENING TORQUE

Nominal Screw Size	Nominal Socket Size	Tightening Torque Ft-Lbs.	Nominal Screw Size	Nominal Socket Size	Tightening Torque Ft-Lbs.
#10-24	5/32	6 Ft-Lbs.	#10-32	5/32	6 Ft-Lbs.
1/4-20	3/16	13 Ft-Lbs.	1/4-28	3/16	15 Ft-Lbs.
5/16-18	1/4	27 Ft-Lbs.	5/16-24	1/4	30 Ft-Lbs.
3/8-16	5/16	48 Ft-Lbs.	3/8-24	5/16	55 Ft-Lbs.
7/16-14	3/8	77 Ft-Lbs.	7/16-20	3/8	86 Ft-Lbs.
1/2-13	3/8	119 Ft-Lbs.	1/2-20	3/8	133 Ft-Lbs.
5/8-11	1/2	234 Ft-Lbs.	5/8-18	1/2	267 Ft-Lbs.
3/4-10	5/8	417 Ft-Lbs.	3/4-16	5/8	467 Ft-Lbs.
7/8-9	3/4	676 Ft-Lbs.	7/8-14	3/4	742 Ft-Lbs.
1-8	3/4	1,009 Ft-Lbs.	1-12	3/4	1,126 Ft-Lbs.
1-1/4-7	7/8	1,600 Ft-Lbs.	1-1/4-12	7/8	1,800 Ft-Lbs.
1-1/2-6	1	2,800 Ft-Lbs.	1-1/2-12	1	3,000 Ft-Lbs.

NOTE: These values are for Socket head cap screws only. Button heads, Flat heads and Set screws have different values. Check the Allen Hand Book for correct torque specifications.